

<b>Produktbezeichnung / Product description</b>	<b>Seite / Page</b>
UNIVERSAL-Messerköpfe 40 mm EURO-System <i>UNIVERSAL head 40 mm EURO system</i> . . . . .	6.2
Profil-Messer und Abweiser für EURO-System 40 mm <i>Profiling blades and deflectors for EURO system 40 mm</i> . . . . .	6.3
Profilübersicht für Profilmesser 40 mm EURO-System <i>Summary of mouldings for profiling blades 40 mm EURO system</i> . . . . .	6.4 – 6.16
<b>NEU</b> Hartmetall MULTI PROFIL System 40 + 50 mm <i>tungsten carbide MULTI PROFIL system 40 + 50 mm</i> . . . . .	6.17 + 6.18
UNIVERSAL-Messerköpfe 50 mm EURO-System <i>UNIVERSAL head 50 mm EURO system</i> . . . . .	6.19
Profilmesser und Abweiser für EURO-System 50 mm <i>Profiling blades and deflectors for EURO system 50 mm</i> . . . . .	6.19

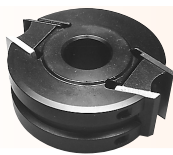

## UNIVERSAL-Messerköpfe und Profilmesser *UNIVERSAL heads and profiling blades*

UNIVERSAL-Profilmesser + Falzkopf 40/50 Z <i>UNIVERSAL profiling and rebating head 40/50 Z</i> . . . . .	6.20
Profilübersicht für Profilmesser 50 mm EURO-System <i>Summary of mouldings for profiling blades 50 mm EURO system</i> . . . . .	6.21 – 6.26
UNIVERSAL-Großprofiler-System 60/80 x 5,5 mm SP + HS <i>UNIVERSAL large profiler system 60/80 x 5,5 mm SP + HS</i> . . . . .	6.27
Profilmesser und Abweiser 60 + 80 x 5,5 mm <i>Profiling blades and deflectors for UNIVERSAL large profiler 60 + 80 x 5,5 mm</i> . . . . .	6.27
Profilübersicht für Profilmesser Großprofiler-System 60 + 80 x 5,5 <i>Summary of mouldings for profiling blades of the large profiler system 60 + 80 x 5,5 mm</i> . . . . .	6.28 – 6.29
<b>NEU</b> Profilmesserkopf - rückenverzahnt / <i>Head for profiling blades - serrated</i> . . . . .	6.30
Preisübersicht Sonderprofile und HS-Profile <i>Prices for special profiles and super-speed steel profiles</i> . . . . .	6.31
Preisübersicht Schärfpreise für UNI-Profilmesser und Sonderprofile <i>Prices of sharpening/UNI profiles and special profiles</i> . . . . .	6.32
<b>NEU</b> CNC Werkzeuge ab Seite <i>CNC Tools from page</i> . . . . .	6.33

## UNIVERSAL-Profilmesserkopf Z 2

für Profilmesser 40 x 4 mm – EURO-System –

## UNIVERSAL head for profiling blades Z 2

EURO-System 40 x 4 mm



### Ausführung:

Werkzeugkörper aus Stahl oder hochfestem Leichtmetall, spandickenbegrenzt, rückschlagarm, vorzugsweise für Handvor-schubarbeiten.

Formschlüssige Messer- und Abweiser-befestigung auf konstanten Flugkreis.

Profilmesser aus **SP-Stahl und HS-Stahl** – seitlich hinterschliften – lieferbar!

Grundwerkzeug wird mit Falzmesser in SP-Stahl bestückt geliefert!

Max. Profiltiefe 17 mm

### Design:

*Universal head for profiling blades, chip-thickness limitation, reduced recoil, preferably for manual feed. Tool made from steel or light metal with high tensile strength. Positive blade and deflector fastening with constant cutting circle. Profiling blades with lateral set-off. Blades made from special steel and high speed steel.*

*max. profile depth 17 mm*



Art.-Nr./Item no. 3500

### Anwendung:

Vorwiegend zum Profilieren von Weich- und Harthölzern (Vollholz unverleimt).

**Profilmesser mit den jeweils zugeordneten Abweiserplatten sind stets paarweise einzusetzen.**

Abb. der lieferbaren Profile siehe folgende Seiten.

### Application:

*Preferably for soft- and hard-textured wood (unglued solid wood).*

**Profiling blades and the corresponding deflector plates to be used in pairs.**

*For illustrations of the available profiles, see separate list.*



Art.-Nr./Item no. 3510

Artikel-Nr. Item no.	Abmessung mm Dimensions mm D/D B/W d/b	Ausführung Quality	Z	n/min <sup>-1</sup>	EURO Stck./pce
3500	93 x 40 x 30	Stahl/Steel	2	5800 – 9000	92,00
3502	100 x 40 x 30	Leichtmetall/Light metal	2	5800 – 9000	86,00
3503	120 x 40 x 30	Stahl/Steel	2	5100 – 7900	126,00
3504	120 x 40 x 30	Leichtmetall/Light metal	2	5100 – 7900	126,00

## UNIVERSAL-Werkzeug-Sätze kompl.

best. aus Holzkassette, gefüllt mit: 1 Messerkopf mit Falzmesser bestückt sowie jeweils paarweise Profilmesser und Abweiser entsprechend nachstehenden Satz-Vorschlägen

(\* bei Bestellung bitte angeben ob der Solokopf in Stahl- oder Leichtmetall-Ausführung geliefert werden soll.)

## UNIVERSAL tool sets, complete

*Consisting of wooden box containing 1 head equipped with rabbeting blade as well as profiling blades and deflectors (in pairs) as propped below*

*(\* When ordering, please quote whether the "Solokopf" head shall be sublied in steel or in light metal.)*

Artikel-Nr. Item no.	Abmessung mm Dimensions mm D/D B/W d/b	Ausführung Quality	EURO Stck./pce
3506	100 x 40 x 30*	UNI-SET m. 6 Profilen Nr. 1, 5, 19, 20, 26, 36/UNI-SET with 6 profiles no. 1, 5, 19, 20, 26, 36	189,00
3507	100 x 40 x 30*	UNI-SET m. 6 Profilen Nr. 1 – 6/UNI-SET with 6 profiles no. 1 – 6	189,00
3510	100 x 40 x 30*	UNI-SET m. 10 Profilen Nr. 1 – 10/UNI-SET with 10 profiles no. 1 – 10	285,50
3520	100 x 40 x 30*	UNI-SET m. 20 Profilen Nr. 1 – 20/UNI-SET with 20 profiles no. 1 – 20	563,00
3530	100 x 40 x 30*	UNI-SET m. 30 Profilen Nr. 1 – 30/UNI-SET with 30 profiles no. 1 – 30	791,00
3551		Holzkassette für 6 Profilsätze, leer/Wooden box for 6 profile sets, empty	27,00
3552		Holzkassette für 12 Profilsätze, leer/Wooden box for 12 profile sets, empty	28,00
3555		Holzkassette für 24 Profilsätze, leer/Wooden box for 24 profile sets, empty	34,00

## Profilmesser und Abweiser (Abgabe aussch. paarweise) Profiling blades and deflectors (only in pairs)

Artikel-Nr. Item no.	Bezeichnung Description	Profil-Nr. Profil no.	EURO Stck./pce
-------------------------	----------------------------	--------------------------	-------------------

### SP-Stahl-Ausführung/Special steel design

3600 – 36135	UNI-Profilmesser 40 x 4 mm/Uni profiling blade 40 x 4 mm	0 – 135	7,30
36136 – 36177	UNI-Profilmesser 40 x 4 mm/Uni profiling blade 40 x 4 mm	136 – 177	9,70

### HS-Ausführung/High speed steel design

36300 – 36393	UNI-Profilmesser 40 x 4 mm/Uni profiling blade 40 x 4 mm	0 – 93	25,50
36394 – 36397	UNI-Profilmesser 40 x 4 mm – Konterprofile 1 – 4/Uni counter profile 1 – 4 – 40 x 4 mm	94 – 97	34,40
36398 – 36400	UNI-Profilmesser 40 x 4 mm – Abplattprofil/Uni counter flattening blade 40 x 4 mm	98 – 100	34,40
36401 – 36435	UNI-Profilmesser 40 x 4 mm/Uni profiling blade 40 x 4 mm	101 – 135	25,50
36436 – 36477	UNI-Profilmesser 40 x 4 mm/Uni profiling blade 40 x 4 mm	136 – 177	34,40

### Abweiser/Deflectors

3700 – 37135	Abweiser 38 mm/Deflectors 38 mm	0 – 135	4,90
37136 – 37177	Abweiser 38 mm/Deflectors 38 mm	136 – 177	8,10

## Blanketts für UNI-Profilmesser Blanks for UNI-profiling blades

Artikel-Nr. Item no.	Bezeichnung Description	A mm	B mm	EURO Stck./pce
36900	Blankett 40 x 4 mm – HS/Blank 40 x 4 mm high-speed steel	32,5	40	13,00
36901	Blankett 40 x 4 mm – SP/Blank 40 x 4 mm special steel	32,5	40	6,40
37999	Blankett 38 x 4 mm – Abweiser/Blank 38 x 4 mm – deflector	31,5	38	6,30

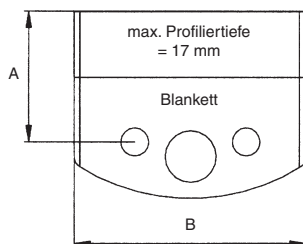

- Sonderprofile nach Zeichnung oder Holzmuster – auf Anfrage!
- *Special profiles to drawing or sample upon request!*
- Sonderprofil – Preisgruppen siehe Seite 6.30
- *Price categories applicable to special profiles: please see page 6.30*
- Schärpreise für Standard- und Sonderprofile siehe Seite 6.31
- *Price of sharpening/standard and special profiles: please see page 6.31*
- Abgabe der Standard- und Sonderprofile immer satzweise
- *All standard and special profiles only available in pairs*

### NEU

Alle Standard-Profile und Sonder-Profile  
40 + 50 mm ab sofort auch in  
**HARTMETALL (HW)-Qualität**  
als MULTI-PROFIL-System lieferbar!

Preise und Details siehe Seiten 6.17 + 6.18

### NEW

All standard-profiles and special-profiles  
40 + 50 mm also available as  
MULTI-PROFIL-System in  
**TUNGSTEN-CARBIDE (TC)-quality**

Prices and details  
please see pages 6.17 + 6.18

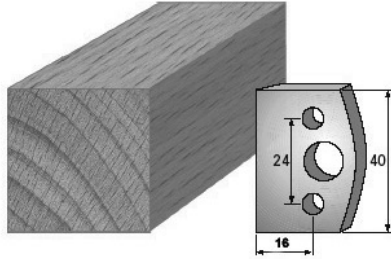

SP-Messer/Blade = Art.-Nr./Item no. 36000  
HS-Messer/Blade = Art.-Nr./Item no. 36298  
Abweiser/Deflector = Art.-Nr./Item no. 37000

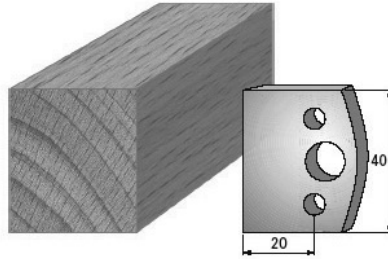

SP-Messer/Blade = Art.-Nr./Item no. 3600  
HS-Messer/Blade = Art.-Nr./Item no. 36300  
Abweiser/Deflector = Art.-Nr./Item no. 3700

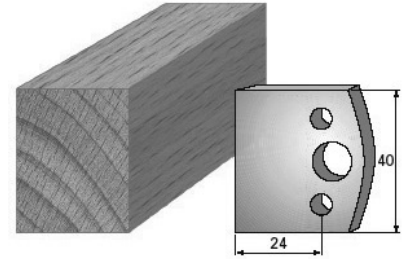

SP-Messer/Blade = Art.-Nr./Item no. 36001  
HS-Messer/Blade = Art.-Nr./Item no. 36299  
Abweiser/Deflector = Art.-Nr./Item no. 37001

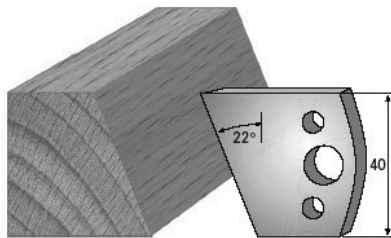

SP-Messer/Blade = Art.-Nr./Item no. 3601  
HS-Messer/Blade = Art.-Nr./Item no. 36301  
Abweiser/Deflector = Art.-Nr./Item no. 3701

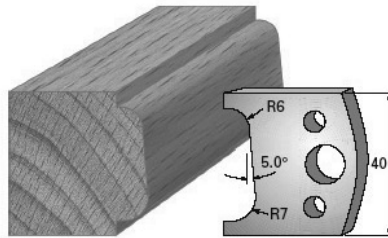

SP-Messer/Blade = Art.-Nr./Item no. 3602  
HS-Messer/Blade = Art.-Nr./Item no. 36302  
Abweiser/Deflector = Art.-Nr./Item no. 3702

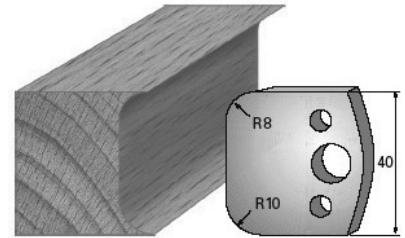

SP-Messer/Blade = Art.-Nr./Item no. 3603  
HS-Messer/Blade = Art.-Nr./Item no. 36303  
Abweiser/Deflector = Art.-Nr./Item no. 3703

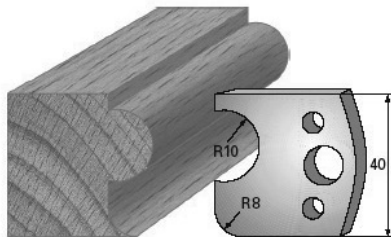

SP-Messer/Blade = Art.-Nr./Item no. 3604  
HS-Messer/Blade = Art.-Nr./Item no. 36304  
Abweiser/Deflector = Art.-Nr./Item no. 3704

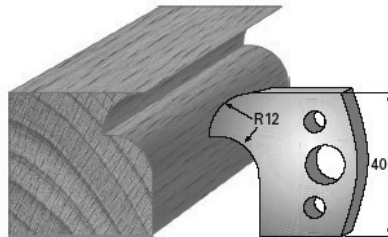

SP-Messer/Blade = Art.-Nr./Item no. 3605  
HS-Messer/Blade = Art.-Nr./Item no. 36305  
Abweiser/Deflector = Art.-Nr./Item no. 3705

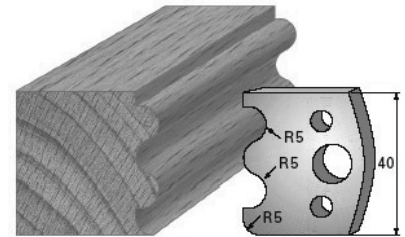

SP-Messer/Blade = Art.-Nr./Item no. 3606  
HS-Messer/Blade = Art.-Nr./Item no. 36306  
Abweiser/Deflector = Art.-Nr./Item no. 3706

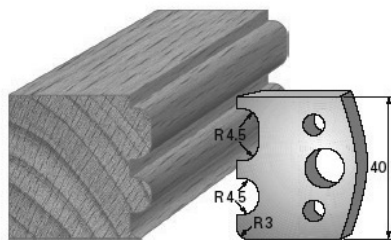

SP-Messer/Blade = Art.-Nr./Item no. 3607  
HS-Messer/Blade = Art.-Nr./Item no. 36307  
Abweiser/Deflector = Art.-Nr./Item no. 3707

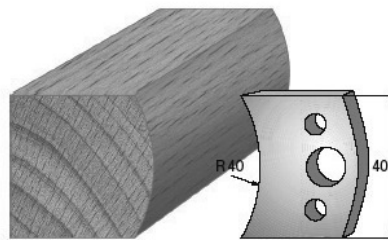

SP-Messer/Blade = Art.-Nr./Item no. 3608  
HS-Messer/Blade = Art.-Nr./Item no. 36308  
Abweiser/Deflector = Art.-Nr./Item no. 3708

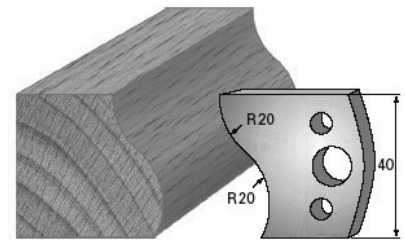

SP-Messer/Blade = Art.-Nr./Item no. 3609  
HS-Messer/Blade = Art.-Nr./Item no. 36309  
Abweiser/Deflector = Art.-Nr./Item no. 3709

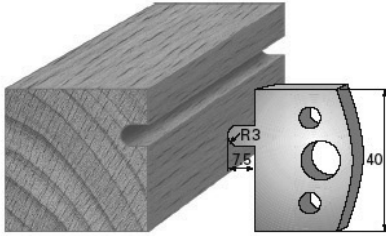

SP-Messer/Blade = Art.-Nr./Item no. 3610  
HS-Messer/Blade = Art.-Nr./Item no. 36310  
Abweiser/Deflector = Art.-Nr./Item no. 3710

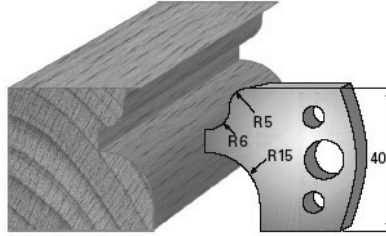

SP-Messer/Blade = Art.-Nr./Item no. 3611  
HS-Messer/Blade = Art.-Nr./Item no. 36311  
Abweiser/Deflector = Art.-Nr./Item no. 3711

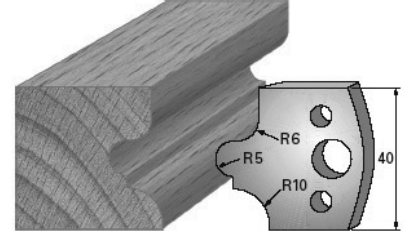

SP-Messer/Blade = Art.-Nr./Item no. 3612  
HS-Messer/Blade = Art.-Nr./Item no. 36312  
Abweiser/Deflector = Art.-Nr./Item no. 3712

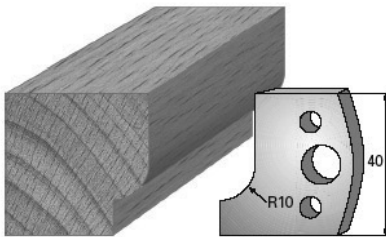

SP-Messer/Blade = Art.-Nr./Item no. 3613  
HS-Messer/Blade = Art.-Nr./Item no. 36313  
Abweiser/Deflector = Art.-Nr./Item no. 3713

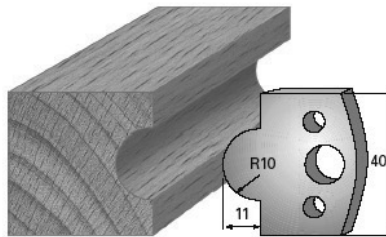

SP-Messer/Blade = Art.-Nr./Item no. 3614  
HS-Messer/Blade = Art.-Nr./Item no. 36314  
Abweiser/Deflector = Art.-Nr./Item no. 3714

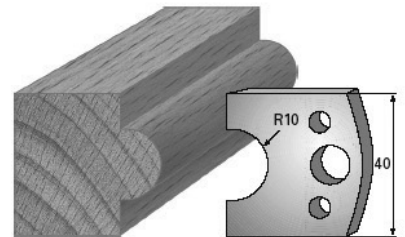

SP-Messer/Blade = Art.-Nr./Item no. 3615  
HS-Messer/Blade = Art.-Nr./Item no. 36315  
Abweiser/Deflector = Art.-Nr./Item no. 3715

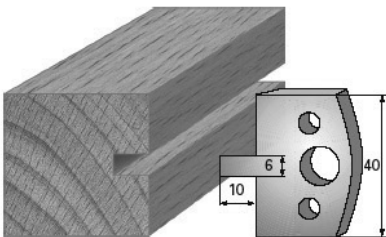

SP-Messer/Blade = Art.-Nr./Item no. 3616  
HS-Messer/Blade = Art.-Nr./Item no. 36316  
Abweiser/Deflector = Art.-Nr./Item no. 3716

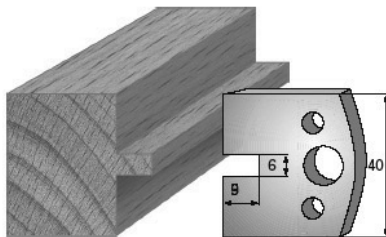

SP-Messer/Blade = Art.-Nr./Item no. 3617  
HS-Messer/Blade = Art.-Nr./Item no. 36317  
Abweiser/Deflector = Art.-Nr./Item no. 3717

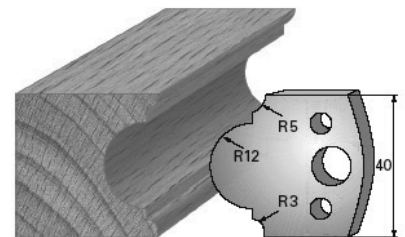

SP-Messer/Blade = Art.-Nr./Item no. 3618  
HS-Messer/Blade = Art.-Nr./Item no. 36318  
Abweiser/Deflector = Art.-Nr./Item no. 3718

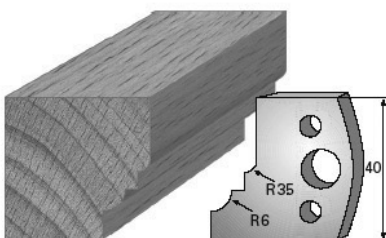

SP-Messer/Blade = Art.-Nr./Item no. 3619  
HS-Messer/Blade = Art.-Nr./Item no. 36319  
Abweiser/Deflector = Art.-Nr./Item no. 3719

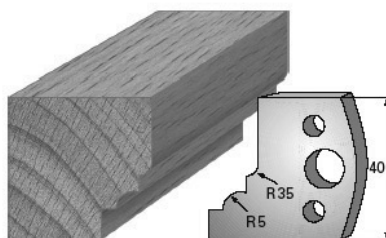

SP-Messer/Blade = Art.-Nr./Item no. 3620  
HS-Messer/Blade = Art.-Nr./Item no. 36320  
Abweiser/Deflector = Art.-Nr./Item no. 3720

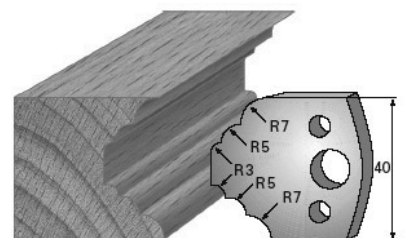

SP-Messer/Blade = Art.-Nr./Item no. 3621  
HS-Messer/Blade = Art.-Nr./Item no. 36321  
Abweiser/Deflector = Art.-Nr./Item no. 3721

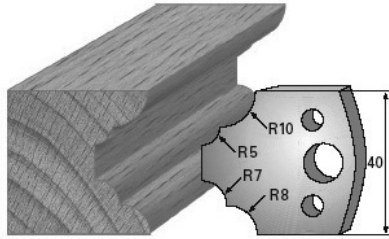

SP-Messer/Blade = Art.-Nr./Item no. 3622  
 HS-Messer/Blade = Art.-Nr./Item no. 36322  
 Abweiser/Deflector = Art.-Nr./Item no. 3722

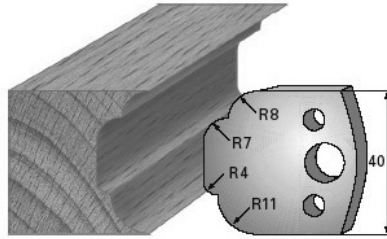

SP-Messer/Blade = Art.-Nr./Item no. 3623  
 HS-Messer/Blade = Art.-Nr./Item no. 36323  
 Abweiser/Deflector = Art.-Nr./Item no. 3723

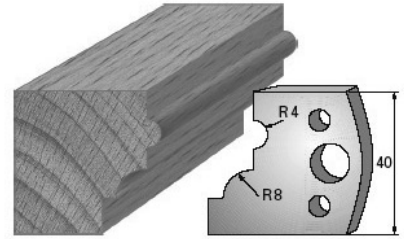

SP-Messer/Blade = Art.-Nr./Item no. 3624  
 HS-Messer/Blade = Art.-Nr./Item no. 36324  
 Abweiser/Deflector = Art.-Nr./Item no. 3724

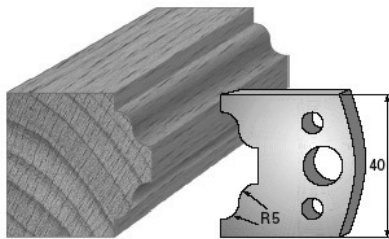

SP-Messer/Blade = Art.-Nr./Item no. 3625  
 HS-Messer/Blade = Art.-Nr./Item no. 36325  
 Abweiser/Deflector = Art.-Nr./Item no. 3725

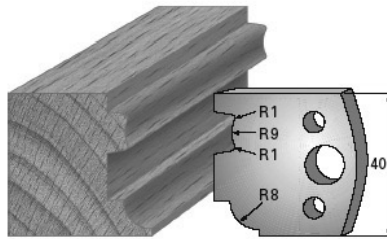

SP-Messer/Blade = Art.-Nr./Item no. 3626  
 HS-Messer/Blade = Art.-Nr./Item no. 36326  
 Abweiser/Deflector = Art.-Nr./Item no. 3726

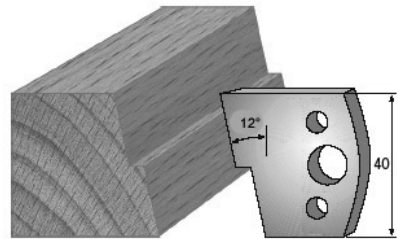

SP-Messer/Blade = Art.-Nr./Item no. 3627  
 HS-Messer/Blade = Art.-Nr./Item no. 36327  
 Abweiser/Deflector = Art.-Nr./Item no. 3727

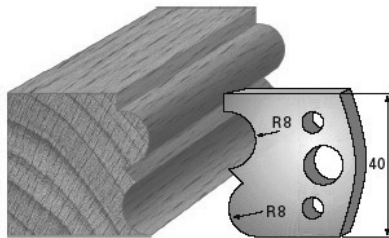

SP-Messer/Blade = Art.-Nr./Item no. 3628  
 HS-Messer/Blade = Art.-Nr./Item no. 36328  
 Abweiser/Deflector = Art.-Nr./Item no. 3728

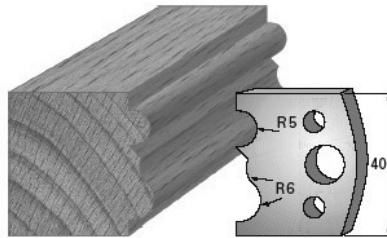

SP-Messer/Blade = Art.-Nr./Item no. 3629  
 HS-Messer/Blade = Art.-Nr./Item no. 36329  
 Abweiser/Deflector = Art.-Nr./Item no. 3729

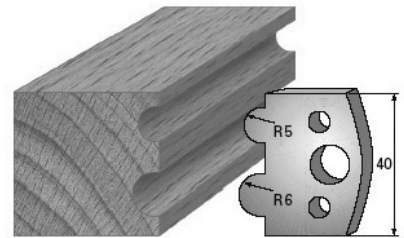

SP-Messer/Blade = Art.-Nr./Item no. 3630  
 HS-Messer/Blade = Art.-Nr./Item no. 36330  
 Abweiser/Deflector = Art.-Nr./Item no. 3730

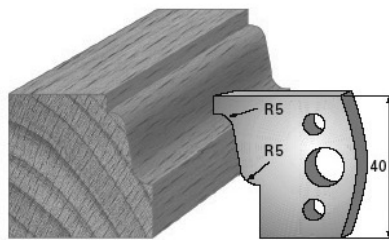

SP-Messer/Blade = Art.-Nr./Item no. 3631  
 HS-Messer/Blade = Art.-Nr./Item no. 36331  
 Abweiser/Deflector = Art.-Nr./Item no. 3731

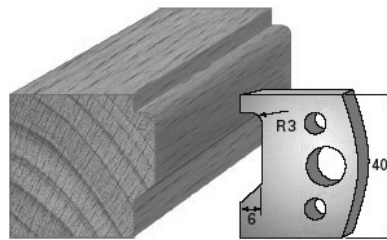

SP-Messer/Blade = Art.-Nr./Item no. 3632  
 HS-Messer/Blade = Art.-Nr./Item no. 36332  
 Abweiser/Deflector = Art.-Nr./Item no. 3732

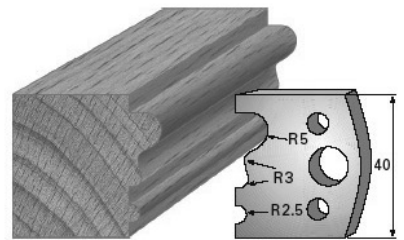

SP-Messer/Blade = Art.-Nr./Item no. 3633  
 HS-Messer/Blade = Art.-Nr./Item no. 36333  
 Abweiser/Deflector = Art.-Nr./Item no. 3733

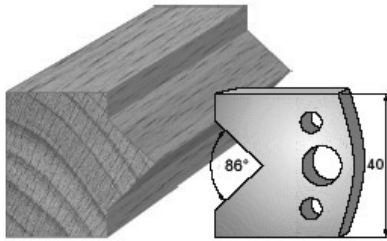

SP-Messer/Blade = Art.-Nr./Item no. 3634  
HS-Messer/Blade = Art.-Nr./Item no. 36334  
Abweiser/Deflector = Art.-Nr./Item no. 3734

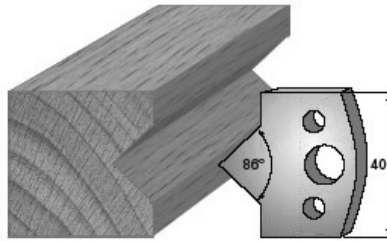

SP-Messer/Blade = Art.-Nr./Item no. 3635  
HS-Messer/Blade = Art.-Nr./Item no. 36335  
Abweiser/Deflector = Art.-Nr./Item no. 3735

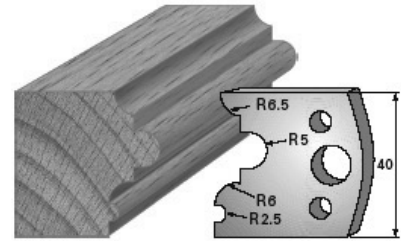

SP-Messer/Blade = Art.-Nr./Item no. 3636  
HS-Messer/Blade = Art.-Nr./Item no. 36336  
Abweiser/Deflector = Art.-Nr./Item no. 3736

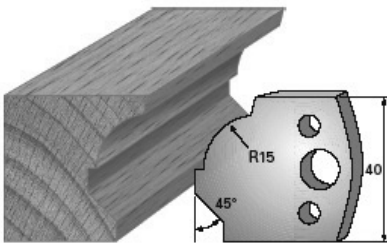

SP-Messer/Blade = Art.-Nr./Item no. 3637  
HS-Messer/Blade = Art.-Nr./Item no. 36337  
Abweiser/Deflector = Art.-Nr./Item no. 3737

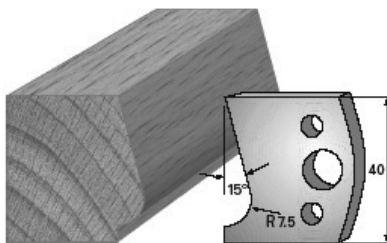

SP-Messer/Blade = Art.-Nr./Item no. 3638  
HS-Messer/Blade = Art.-Nr./Item no. 36338  
Abweiser/Deflector = Art.-Nr./Item no. 3738

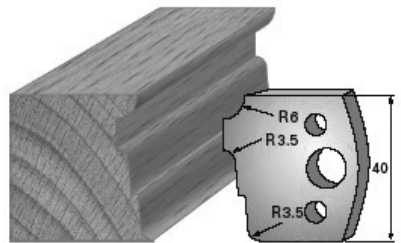

SP-Messer/Blade = Art.-Nr./Item no. 3639  
HS-Messer/Blade = Art.-Nr./Item no. 36339  
Abweiser/Deflector = Art.-Nr./Item no. 3739

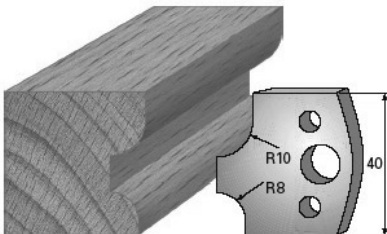

SP-Messer/Blade = Art.-Nr./Item no. 3640  
HS-Messer/Blade = Art.-Nr./Item no. 36340  
Abweiser/Deflector = Art.-Nr./Item no. 3740

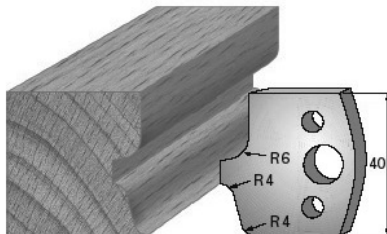

SP-Messer/Blade = Art.-Nr./Item no. 3641  
HS-Messer/Blade = Art.-Nr./Item no. 36341  
Abweiser/Deflector = Art.-Nr./Item no. 3741

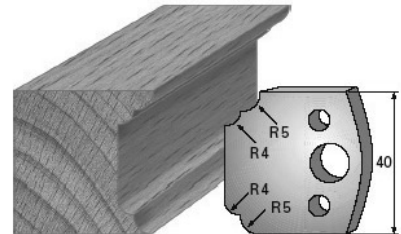

SP-Messer/Blade = Art.-Nr./Item no. 3642  
HS-Messer/Blade = Art.-Nr./Item no. 36342  
Abweiser/Deflector = Art.-Nr./Item no. 3742

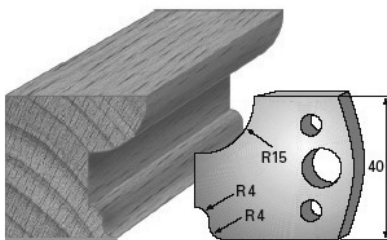

SP-Messer/Blade = Art.-Nr./Item no. 3643  
HS-Messer/Blade = Art.-Nr./Item no. 36343  
Abweiser/Deflector = Art.-Nr./Item no. 3743

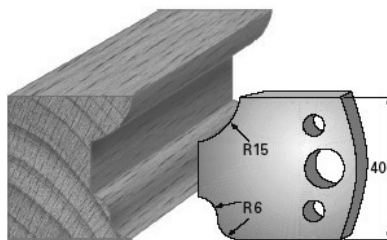

SP-Messer/Blade = Art.-Nr./Item no. 3644  
HS-Messer/Blade = Art.-Nr./Item no. 36344  
Abweiser/Deflector = Art.-Nr./Item no. 3744

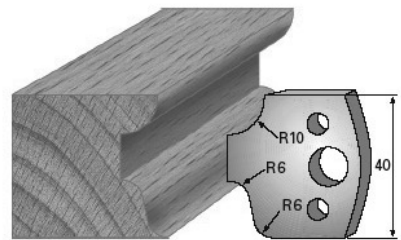

SP-Messer/Blade = Art.-Nr./Item no. 3645  
HS-Messer/Blade = Art.-Nr./Item no. 36345  
Abweiser/Deflector = Art.-Nr./Item no. 3745

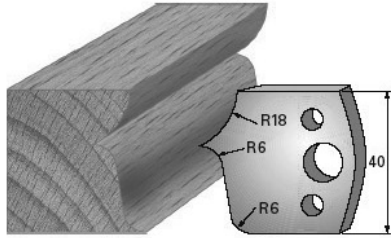

SP-Messer/Blade = Art.-Nr./Item no. 3646  
 HS-Messer/Blade = Art.-Nr./Item no. 36346  
 Abweiser/Deflector = Art.-Nr./Item no. 3746

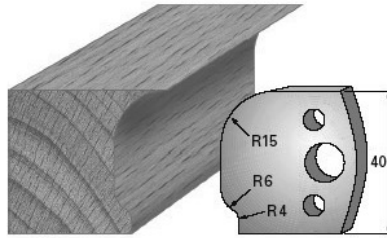

SP-Messer/Blade = Art.-Nr./Item no. 3647  
 HS-Messer/Blade = Art.-Nr./Item no. 36347  
 Abweiser/Deflector = Art.-Nr./Item no. 3747

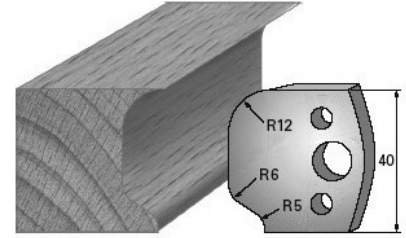

SP-Messer/Blade = Art.-Nr./Item no. 3648  
 HS-Messer/Blade = Art.-Nr./Item no. 36348  
 Abweiser/Deflector = Art.-Nr./Item no. 3748

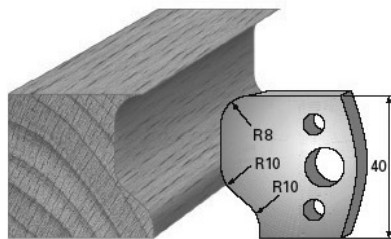

SP-Messer/Blade = Art.-Nr./Item no. 3649  
 HS-Messer/Blade = Art.-Nr./Item no. 36349  
 Abweiser/Deflector = Art.-Nr./Item no. 3749

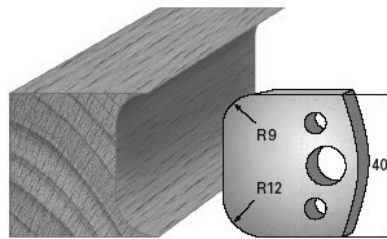

SP-Messer/Blade = Art.-Nr./Item no. 3650  
 HS-Messer/Blade = Art.-Nr./Item no. 36350  
 Abweiser/Deflector = Art.-Nr./Item no. 3750

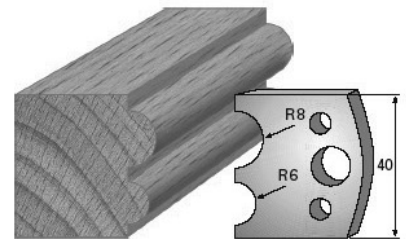

SP-Messer/Blade = Art.-Nr./Item no. 3651  
 HS-Messer/Blade = Art.-Nr./Item no. 36351  
 Abweiser/Deflector = Art.-Nr./Item no. 3751

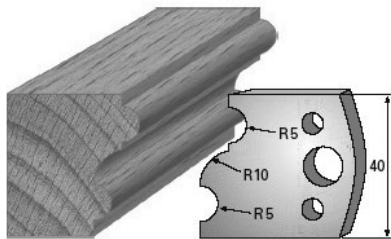

SP-Messer/Blade = Art.-Nr./Item no. 3652  
 HS-Messer/Blade = Art.-Nr./Item no. 36352  
 Abweiser/Deflector = Art.-Nr./Item no. 3752

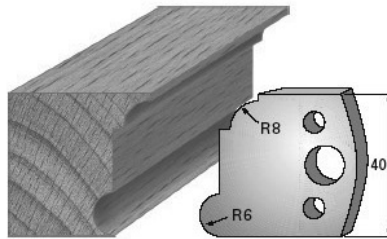

SP-Messer/Blade = Art.-Nr./Item no. 3653  
 HS-Messer/Blade = Art.-Nr./Item no. 36353  
 Abweiser/Deflector = Art.-Nr./Item no. 3753

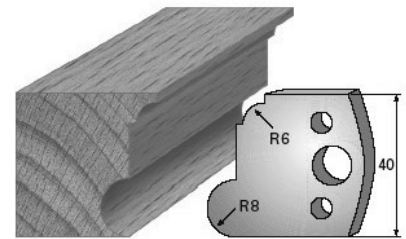

SP-Messer/Blade = Art.-Nr./Item no. 3654  
 HS-Messer/Blade = Art.-Nr./Item no. 36354  
 Abweiser/Deflector = Art.-Nr./Item no. 3754

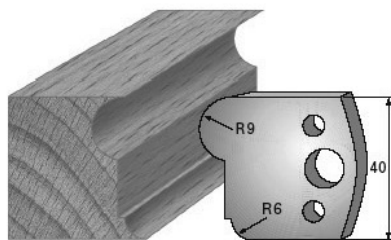

SP-Messer/Blade = Art.-Nr./Item no. 3655  
 HS-Messer/Blade = Art.-Nr./Item no. 36355  
 Abweiser/Deflector = Art.-Nr./Item no. 3755

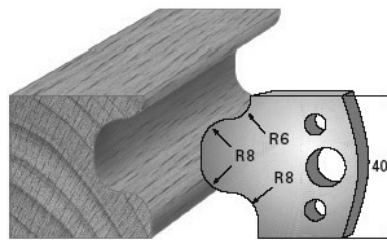

SP-Messer/Blade = Art.-Nr./Item no. 3656  
 HS-Messer/Blade = Art.-Nr./Item no. 36356  
 Abweiser/Deflector = Art.-Nr./Item no. 3756

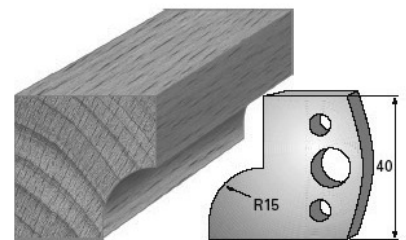

SP-Messer/Blade = Art.-Nr./Item no. 3657  
 HS-Messer/Blade = Art.-Nr./Item no. 36357  
 Abweiser/Deflector = Art.-Nr./Item no. 3757



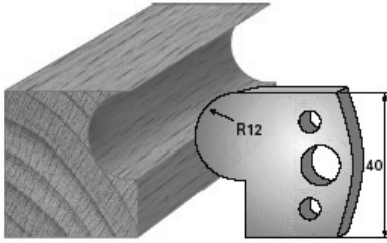

SP-Messer/Blade = Art.-Nr./Item no. 3658  
HS-Messer/Blade = Art.-Nr./Item no. 36358  
Abweiser/Deflector = Art.-Nr./Item no. 3758

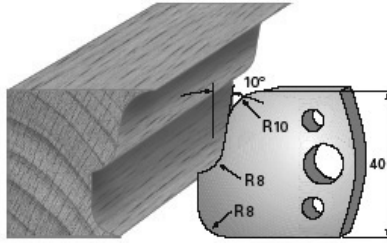

SP-Messer/Blade = Art.-Nr./Item no. 3659  
HS-Messer/Blade = Art.-Nr./Item no. 36359  
Abweiser/Deflector = Art.-Nr./Item no. 3759

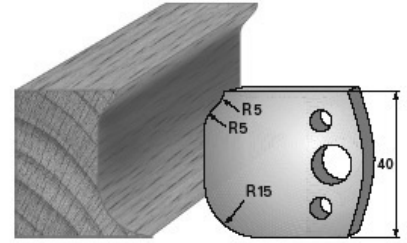

SP-Messer/Blade = Art.-Nr./Item no. 3660  
HS-Messer/Blade = Art.-Nr./Item no. 36360  
Abweiser/Deflector = Art.-Nr./Item no. 3760

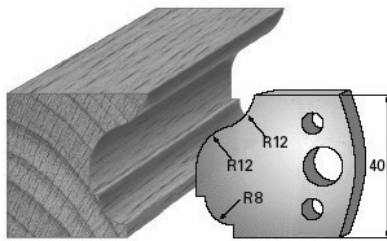

SP-Messer/Blade = Art.-Nr./Item no. 3661  
HS-Messer/Blade = Art.-Nr./Item no. 36361  
Abweiser/Deflector = Art.-Nr./Item no. 3761

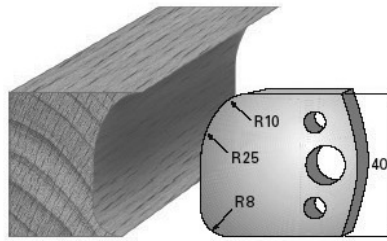

SP-Messer/Blade = Art.-Nr./Item no. 3662  
HS-Messer/Blade = Art.-Nr./Item no. 36362  
Abweiser/Deflector = Art.-Nr./Item no. 3762

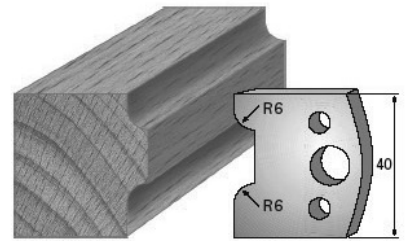

SP-Messer/Blade = Art.-Nr./Item no. 3663  
HS-Messer/Blade = Art.-Nr./Item no. 36363  
Abweiser/Deflector = Art.-Nr./Item no. 3763

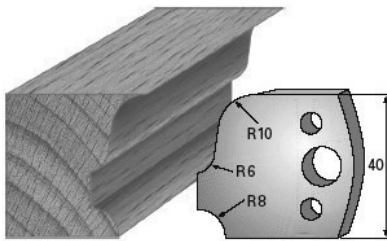

SP-Messer/Blade = Art.-Nr./Item no. 3664  
HS-Messer/Blade = Art.-Nr./Item no. 36364  
Abweiser/Deflector = Art.-Nr./Item no. 3764

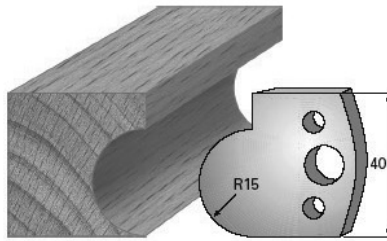

SP-Messer/Blade = Art.-Nr./Item no. 3665  
HS-Messer/Blade = Art.-Nr./Item no. 36365  
Abweiser/Deflector = Art.-Nr./Item no. 3765

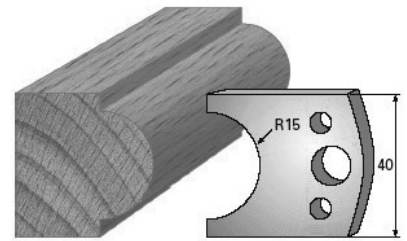

SP-Messer/Blade = Art.-Nr./Item no. 3666  
HS-Messer/Blade = Art.-Nr./Item no. 36366  
Abweiser/Deflector = Art.-Nr./Item no. 3766

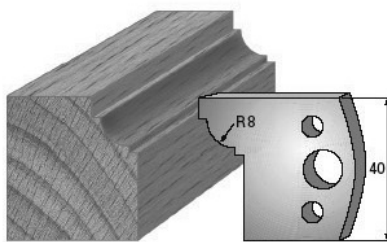

SP-Messer/Blade = Art.-Nr./Item no. 3667  
HS-Messer/Blade = Art.-Nr./Item no. 36367  
Abweiser/Deflector = Art.-Nr./Item no. 3767

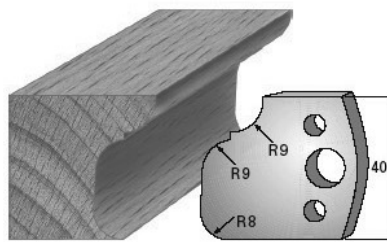

SP-Messer/Blade = Art.-Nr./Item no. 3668  
HS-Messer/Blade = Art.-Nr./Item no. 36368  
Abweiser/Deflector = Art.-Nr./Item no. 3768

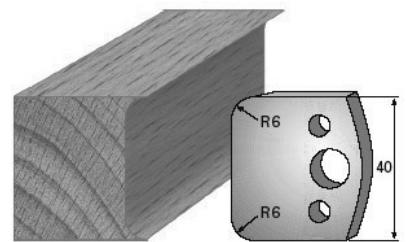

SP-Messer/Blade = Art.-Nr./Item no. 3669  
HS-Messer/Blade = Art.-Nr./Item no. 36369  
Abweiser/Deflector = Art.-Nr./Item no. 3769

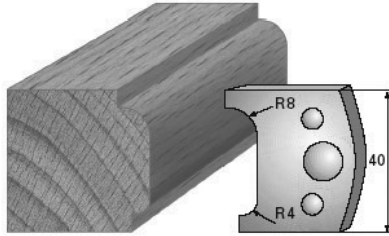

SP-Messer/Blade = Art.-Nr./Item no. 3670  
HS-Messer/Blade = Art.-Nr./Item no. 36370  
Abweiser/Deflector = Art.-Nr./Item no. 3770

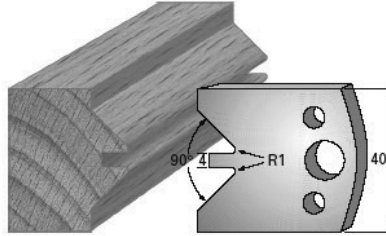

SP-Messer/Blade = Art.-Nr./Item no. 3671  
HS-Messer/Blade = Art.-Nr./Item no. 36371  
Abweiser/Deflector = Art.-Nr./Item no. 3771

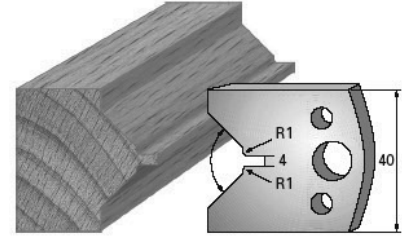

SP-Messer/Blade = Art.-Nr./Item no. 3672  
HS-Messer/Blade = Art.-Nr./Item no. 36372  
Abweiser/Deflector = Art.-Nr./Item no. 3772

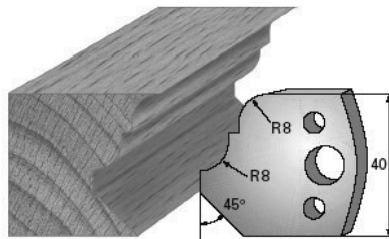

SP-Messer/Blade = Art.-Nr./Item no. 3673  
HS-Messer/Blade = Art.-Nr./Item no. 36373  
Abweiser/Deflector = Art.-Nr./Item no. 3773

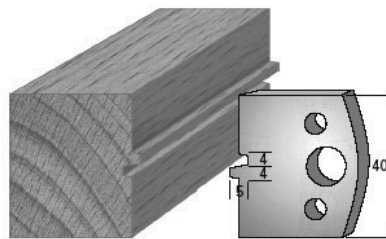

SP-Messer/Blade = Art.-Nr./Item no. 3674  
HS-Messer/Blade = Art.-Nr./Item no. 36374  
Abweiser/Deflector = Art.-Nr./Item no. 3774

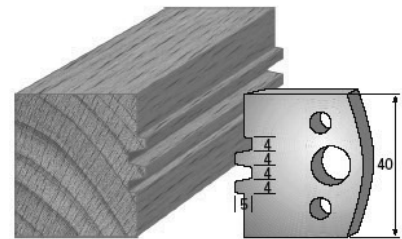

SP-Messer/Blade = Art.-Nr./Item no. 3675  
HS-Messer/Blade = Art.-Nr./Item no. 36375  
Abweiser/Deflector = Art.-Nr./Item no. 3775

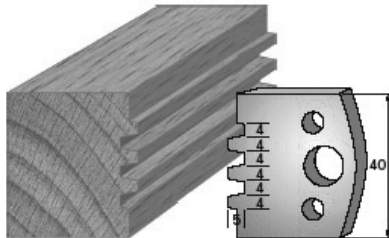

SP-Messer/Blade = Art.-Nr./Item no. 3676  
HS-Messer/Blade = Art.-Nr./Item no. 36376  
Abweiser/Deflector = Art.-Nr./Item no. 3776

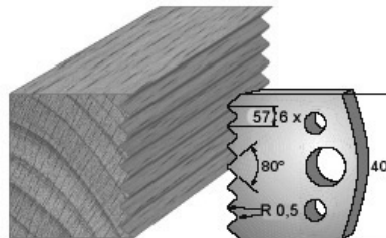

SP-Messer/Blade = Art.-Nr./Item no. 3677  
HS-Messer/Blade = Art.-Nr./Item no. 36377  
Abweiser/Deflector = Art.-Nr./Item no. 3777

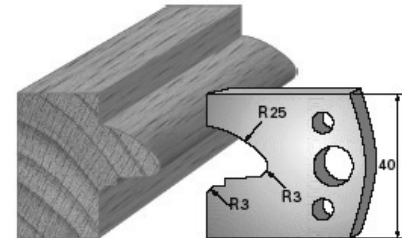

SP-Messer/Blade = Art.-Nr./Item no. 3678  
HS-Messer/Blade = Art.-Nr./Item no. 36378  
Abweiser/Deflector = Art.-Nr./Item no. 3778

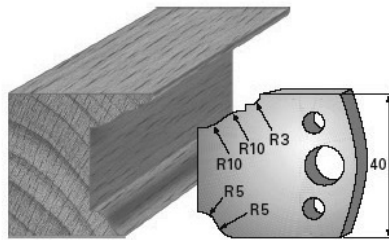

SP-Messer/Blade = Art.-Nr./Item no. 3679  
HS-Messer/Blade = Art.-Nr./Item no. 36379  
Abweiser/Deflector = Art.-Nr./Item no. 3779

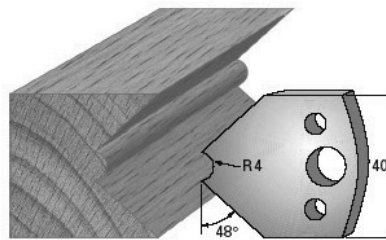

SP-Messer/Blade = Art.-Nr./Item no. 3680  
HS-Messer/Blade = Art.-Nr./Item no. 36380  
Abweiser/Deflector = Art.-Nr./Item no. 3780

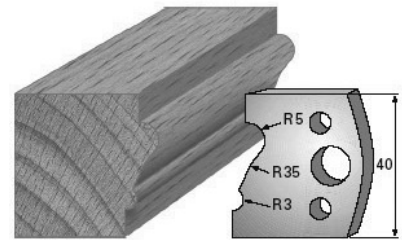

SP-Messer/Blade = Art.-Nr./Item no. 3681  
HS-Messer/Blade = Art.-Nr./Item no. 36381  
Abweiser/Deflector = Art.-Nr./Item no. 3781

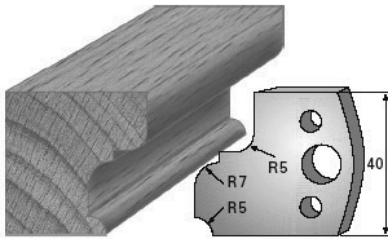

SP-Messer/Blade = Art.-Nr./Item no. 3682  
HS-Messer/Blade = Art.-Nr./Item no. 36382  
Abweiser/Deflector = Art.-Nr./Item no. 3782

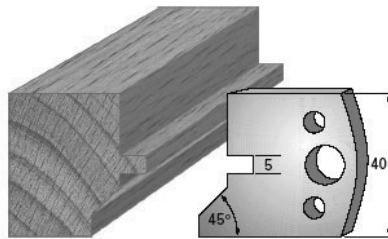

SP-Messer/Blade = Art.-Nr./Item no. 3683  
HS-Messer/Blade = Art.-Nr./Item no. 36383  
Abweiser/Deflector = Art.-Nr./Item no. 3783

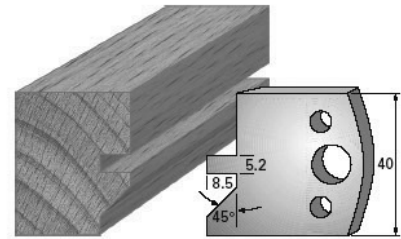

SP-Messer/Blade = Art.-Nr./Item no. 3684  
HS-Messer/Blade = Art.-Nr./Item no. 36384  
Abweiser/Deflector = Art.-Nr./Item no. 3784

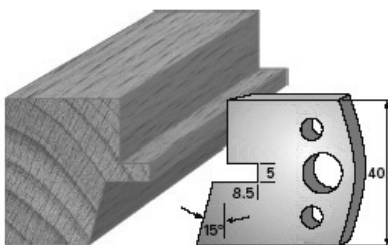

SP-Messer/Blade = Art.-Nr./Item no. 3685  
HS-Messer/Blade = Art.-Nr./Item no. 36385  
Abweiser/Deflector = Art.-Nr./Item no. 3785

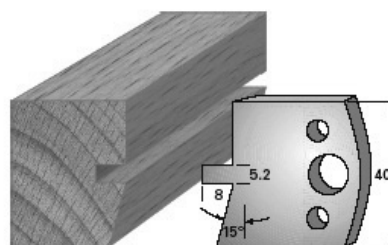

SP-Messer/Blade = Art.-Nr./Item no. 3686  
HS-Messer/Blade = Art.-Nr./Item no. 36386  
Abweiser/Deflector = Art.-Nr./Item no. 3786

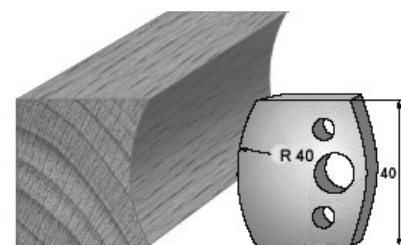

SP-Messer/Blade = Art.-Nr./Item no. 3687  
HS-Messer/Blade = Art.-Nr./Item no. 36387  
Abweiser/Deflector = Art.-Nr./Item no. 3787

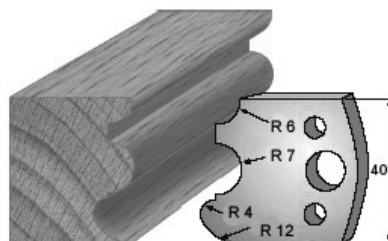

SP-Messer/Blade = Art.-Nr./Item no. 3688  
HS-Messer/Blade = Art.-Nr./Item no. 36388  
Abweiser/Deflector = Art.-Nr./Item no. 3788

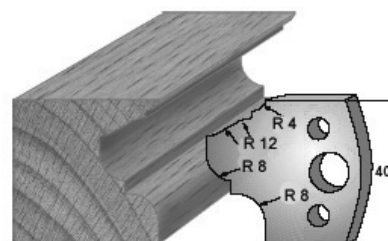

SP-Messer/Blade = Art.-Nr./Item no. 3689  
HS-Messer/Blade = Art.-Nr./Item no. 36389  
Abweiser/Deflector = Art.-Nr./Item no. 3789

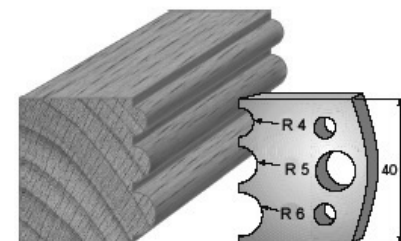

SP-Messer/Blade = Art.-Nr./Item no. 3690  
HS-Messer/Blade = Art.-Nr./Item no. 36390  
Abweiser/Deflector = Art.-Nr./Item no. 3790

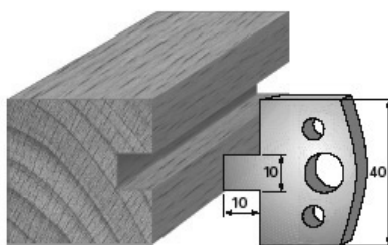

SP-Messer/Blade = Art.-Nr./Item no. 3691  
HS-Messer/Blade = Art.-Nr./Item no. 36391  
Abweiser/Deflector = Art.-Nr./Item no. 3791

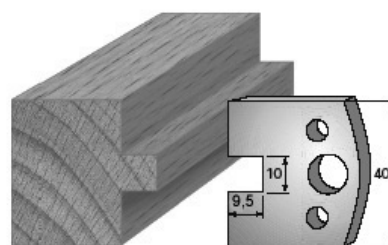

SP-Messer/Blade = Art.-Nr./Item no. 3692  
HS-Messer/Blade = Art.-Nr./Item no. 36392  
Abweiser/Deflector = Art.-Nr./Item no. 3792

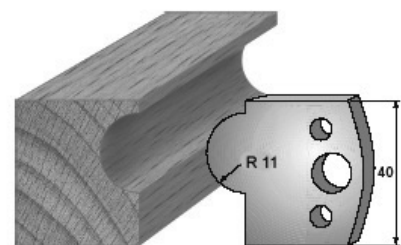

SP-Messer/Blade = Art.-Nr./Item no. 3693  
HS-Messer/Blade = Art.-Nr./Item no. 36393  
Abweiser/Deflector = Art.-Nr./Item no. 3793

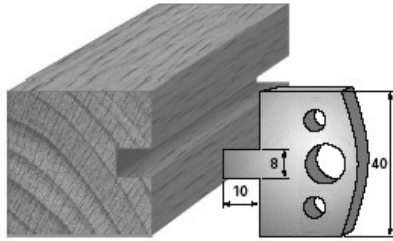

SP-Messer/Blade = Art.-Nr./Item no. 3694  
HS-Messer/Blade = Art.-Nr./Item no. 36394  
Abweiser/Deflector = Art.-Nr./Item no. 3794

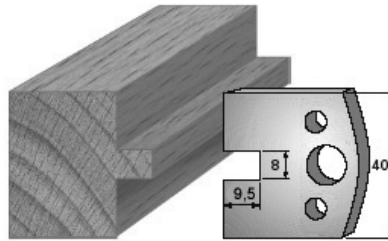

SP-Messer/Blade = Art.-Nr./Item no. 3695  
HS-Messer/Blade = Art.-Nr./Item no. 36395  
Abweiser/Deflector = Art.-Nr./Item no. 3795

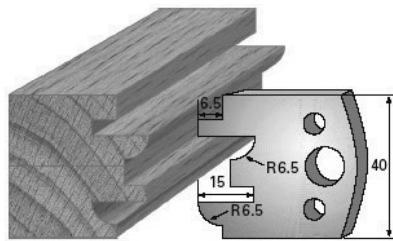
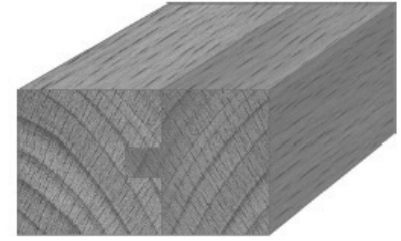

SP-Messer/Blade = Art.-Nr./Item no. 3696 - Konter 1  
HS-Messer/Blade = Art.-Nr./Item no. 36396  
Abweiser/Deflector = Art.-Nr./Item no. 3796

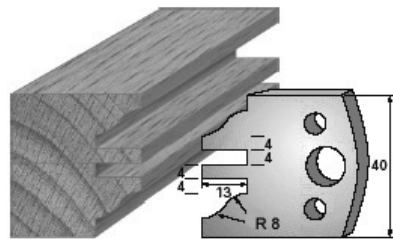
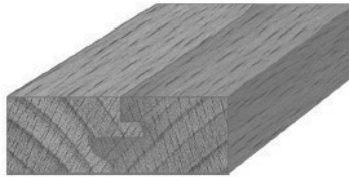

SP-Messer/Blade = Art.-Nr./Item no. 3697 - Konter 2  
HS-Messer/Blade = Art.-Nr./Item no. 36397  
Abweiser/Deflector = Art.-Nr./Item no. 3797

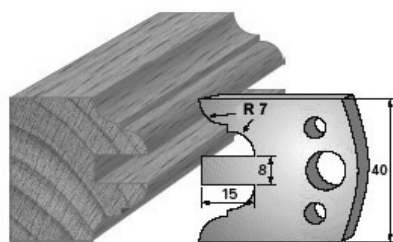
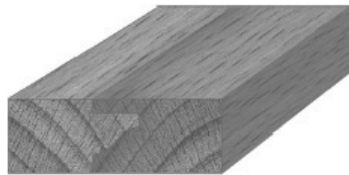

SP-Messer/Blade = Art.-Nr./Item no. 3698 - Konter 3  
HS-Messer/Blade = Art.-Nr./Item no. 36398  
Abweiser/Deflector = Art.-Nr./Item no. 3798

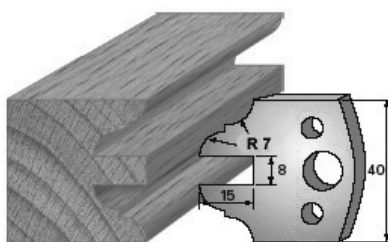

SP-Messer/Blade = Art.-Nr./Item no. 3699 - Konter 4  
HS-Messer/Blade = Art.-Nr./Item no. 36399  
Abweiser/Deflector = Art.-Nr./Item no. 3799

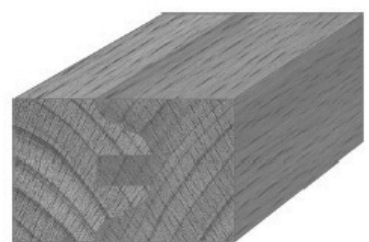

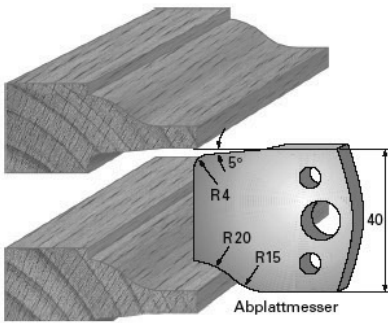

Abplattmesser

SP-Messer/Blade = Art.-Nr./Item no. 36100  
HS-Messer/Blade = Art.-Nr./Item no. 36400  
Abweiser/Deflector = Art.-Nr./Item no. 37100

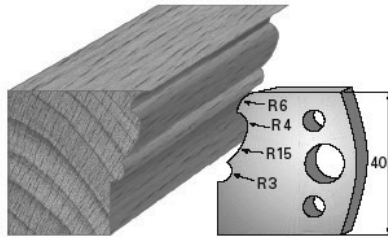

SP-Messer/Blade = Art.-Nr./Item no. 36101  
HS-Messer/Blade = Art.-Nr./Item no. 36401  
Abweiser/Deflector = Art.-Nr./Item no. 37101

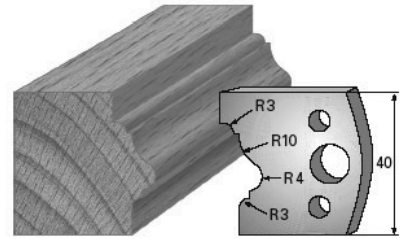

SP-Messer/Blade = Art.-Nr./Item no. 36102  
HS-Messer/Blade = Art.-Nr./Item no. 36402  
Abweiser/Deflector = Art.-Nr./Item no. 37102

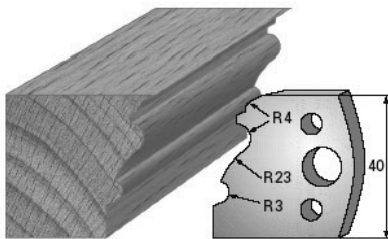

SP-Messer/Blade = Art.-Nr./Item no. 36103  
HS-Messer/Blade = Art.-Nr./Item no. 36403  
Abweiser/Deflector = Art.-Nr./Item no. 37103

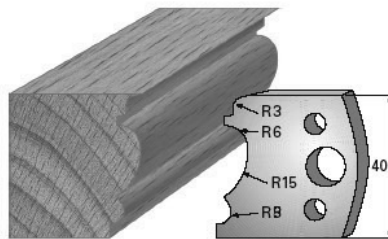

SP-Messer/Blade = Art.-Nr./Item no. 36104  
HS-Messer/Blade = Art.-Nr./Item no. 36404  
Abweiser/Deflector = Art.-Nr./Item no. 37104

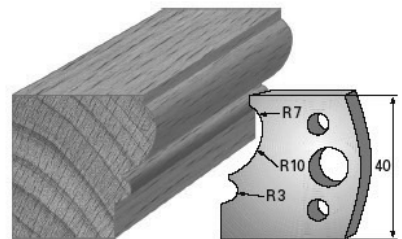

SP-Messer/Blade = Art.-Nr./Item no. 36105  
HS-Messer/Blade = Art.-Nr./Item no. 36405  
Abweiser/Deflector = Art.-Nr./Item no. 37105

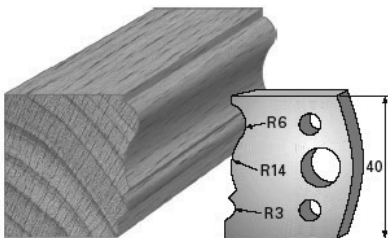

SP-Messer/Blade = Art.-Nr./Item no. 36106  
HS-Messer/Blade = Art.-Nr./Item no. 36406  
Abweiser/Deflector = Art.-Nr./Item no. 37106

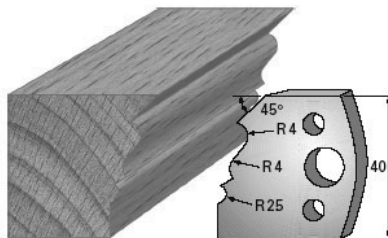

SP-Messer/Blade = Art.-Nr./Item no. 36107  
HS-Messer/Blade = Art.-Nr./Item no. 36407  
Abweiser/Deflector = Art.-Nr./Item no. 37107

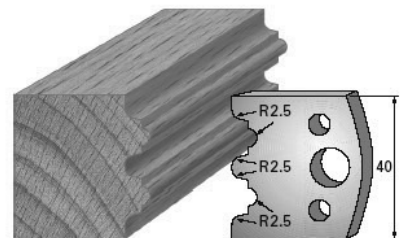

SP-Messer/Blade = Art.-Nr./Item no. 36108  
HS-Messer/Blade = Art.-Nr./Item no. 36408  
Abweiser/Deflector = Art.-Nr./Item no. 37108

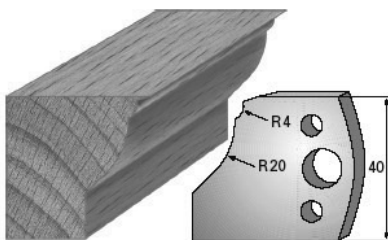

SP-Messer/Blade = Art.-Nr./Item no. 36109  
HS-Messer/Blade = Art.-Nr./Item no. 36409  
Abweiser/Deflector = Art.-Nr./Item no. 37109

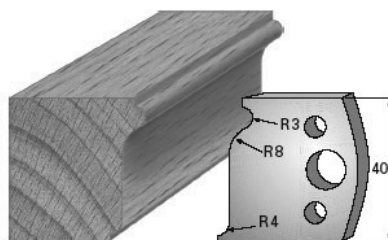

SP-Messer/Blade = Art.-Nr./Item no. 36110  
HS-Messer/Blade = Art.-Nr./Item no. 36410  
Abweiser/Deflector = Art.-Nr./Item no. 37110

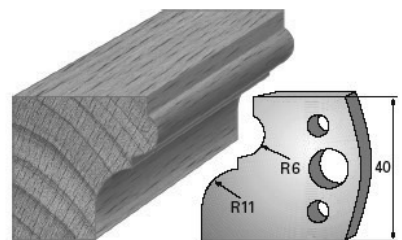

SP-Messer/Blade = Art.-Nr./Item no. 36111  
HS-Messer/Blade = Art.-Nr./Item no. 36411  
Abweiser/Deflector = Art.-Nr./Item no. 37111

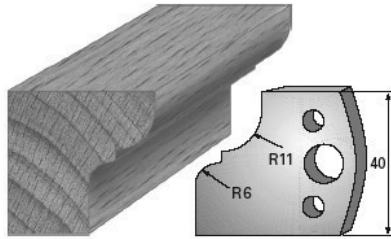

SP-Messer/Blade = Art.-Nr./Item no. 36112  
HS-Messer/Blade = Art.-Nr./Item no. 36412  
Abweiser/Deflector = Art.-Nr./Item no. 37112

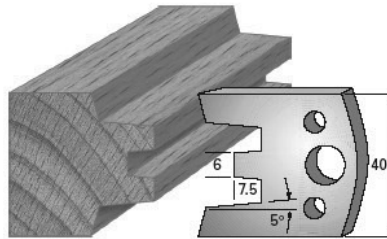

SP-Messer/Blade = Art.-Nr./Item no. 36113  
HS-Messer/Blade = Art.-Nr./Item no. 36413  
Abweiser/Deflector = Art.-Nr./Item no. 37113

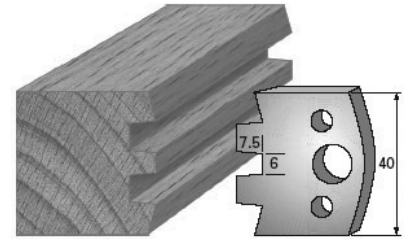

SP-Messer/Blade = Art.-Nr./Item no. 36114  
HS-Messer/Blade = Art.-Nr./Item no. 36414  
Abweiser/Deflector = Art.-Nr./Item no. 37114

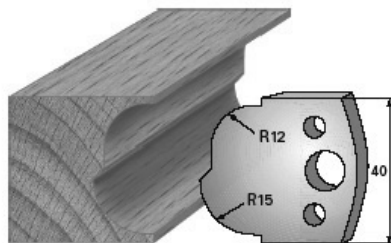

SP-Messer/Blade = Art.-Nr./Item no. 36115  
HS-Messer/Blade = Art.-Nr./Item no. 36415  
Abweiser/Deflector = Art.-Nr./Item no. 37115

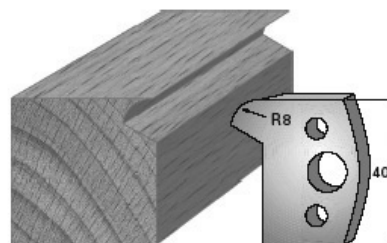

SP-Messer/Blade = Art.-Nr./Item no. 36116  
HS-Messer/Blade = Art.-Nr./Item no. 36416  
Abweiser/Deflector = Art.-Nr./Item no. 37116

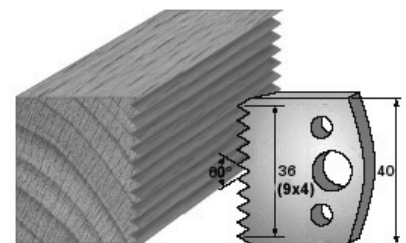

SP-Messer/Blade = Art.-Nr./Item no. 36117  
HS-Messer/Blade = Art.-Nr./Item no. 36417  
Abweiser/Deflector = Art.-Nr./Item no. 37117

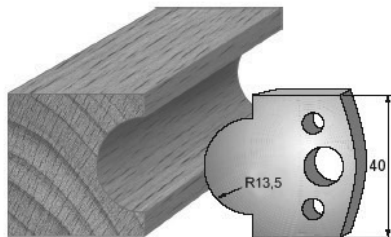

SP-Messer/Blade = Art.-Nr./Item no. 36118  
HS-Messer/Blade = Art.-Nr./Item no. 36418  
Abweiser/Deflector = Art.-Nr./Item no. 37118

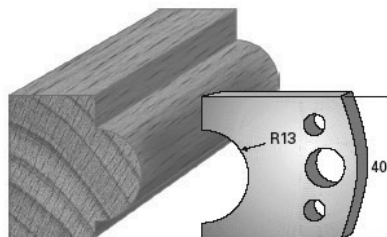

SP-Messer/Blade = Art.-Nr./Item no. 36119  
HS-Messer/Blade = Art.-Nr./Item no. 36419  
Abweiser/Deflector = Art.-Nr./Item no. 37119

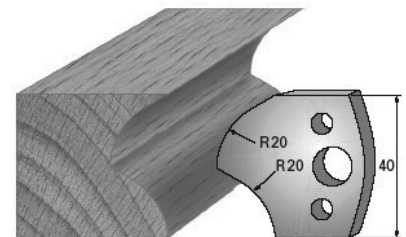

SP-Messer/Blade = Art.-Nr./Item no. 36120  
HS-Messer/Blade = Art.-Nr./Item no. 36420  
Abweiser/Deflector = Art.-Nr./Item no. 37120

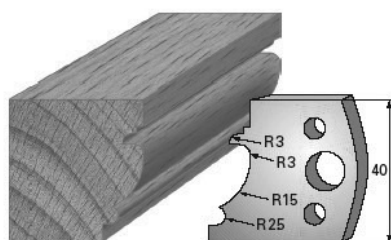

SP-Messer/Blade = Art.-Nr./Item no. 36121  
HS-Messer/Blade = Art.-Nr./Item no. 36421  
Abweiser/Deflector = Art.-Nr./Item no. 37121

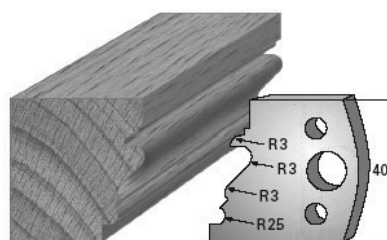

SP-Messer/Blade = Art.-Nr./Item no. 36122  
HS-Messer/Blade = Art.-Nr./Item no. 36422  
Abweiser/Deflector = Art.-Nr./Item no. 37122

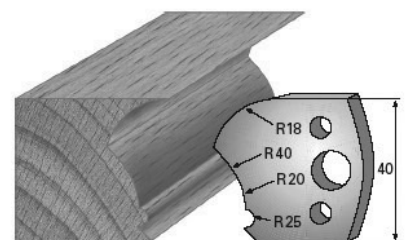

SP-Messer/Blade = Art.-Nr./Item no. 36123  
HS-Messer/Blade = Art.-Nr./Item no. 36423  
Abweiser/Deflector = Art.-Nr./Item no. 37123

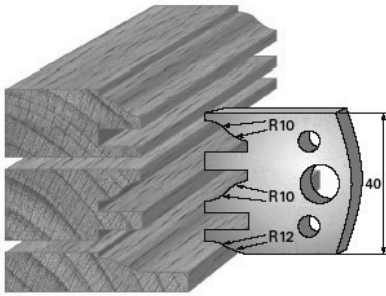

SP-Messer/Blade = Art.-Nr./Item no. 36124  
HS-Messer/Blade = Art.-Nr./Item no. 36424  
Abweiser/Deflector = Art.-Nr./Item no. 37124

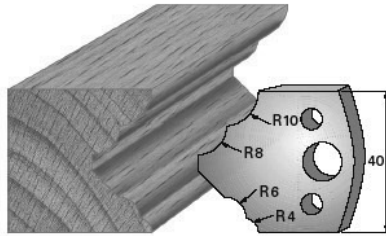

SP-Messer/Blade = Art.-Nr./Item no. 36125  
HS-Messer/Blade = Art.-Nr./Item no. 36425  
Abweiser/Deflector = Art.-Nr./Item no. 37125

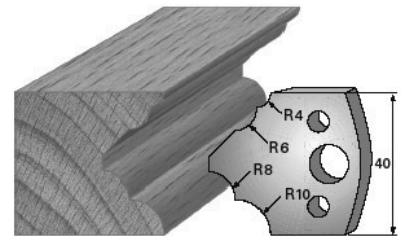

SP-Messer/Blade = Art.-Nr./Item no. 36126  
HS-Messer/Blade = Art.-Nr./Item no. 36426  
Abweiser/Deflector = Art.-Nr./Item no. 37126

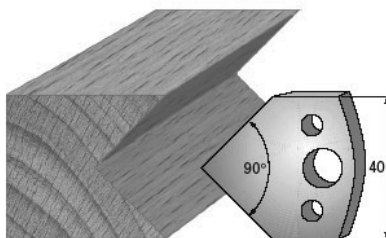

SP-Messer/Blade = Art.-Nr./Item no. 36127  
HS-Messer/Blade = Art.-Nr./Item no. 36427  
Abweiser/Deflector = Art.-Nr./Item no. 37127

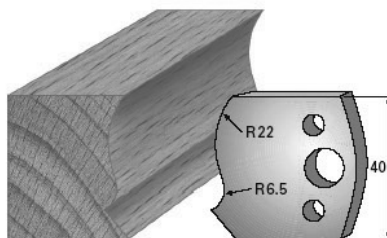

SP-Messer/Blade = Art.-Nr./Item no. 36128  
HS-Messer/Blade = Art.-Nr./Item no. 36428  
Abweiser/Deflector = Art.-Nr./Item no. 37128

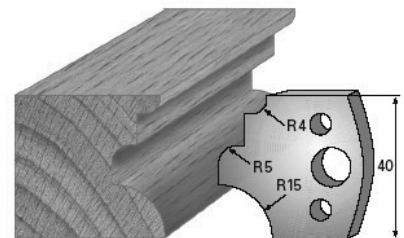

SP-Messer/Blade = Art.-Nr./Item no. 36129  
HS-Messer/Blade = Art.-Nr./Item no. 36429  
Abweiser/Deflector = Art.-Nr./Item no. 37129

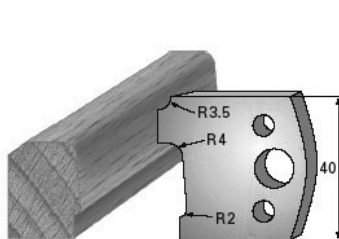

SP-Messer/Blade = Art.-Nr./Item no. 36130  
HS-Messer/Blade = Art.-Nr./Item no. 36430  
Abweiser/Deflector = Art.-Nr./Item no. 37130

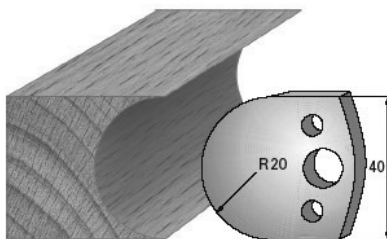

SP-Messer/Blade = Art.-Nr./Item no. 36131  
HS-Messer/Blade = Art.-Nr./Item no. 36431  
Abweiser/Deflector = Art.-Nr./Item no. 37131

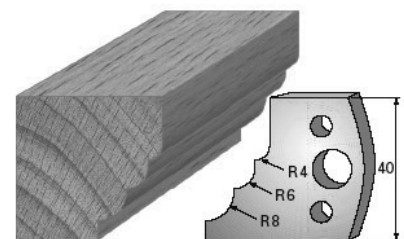

SP-Messer/Blade = Art.-Nr./Item no. 36132  
HS-Messer/Blade = Art.-Nr./Item no. 36432  
Abweiser/Deflector = Art.-Nr./Item no. 37132

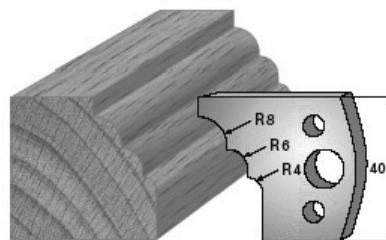

SP-Messer/Blade = Art.-Nr./Item no. 36133  
HS-Messer/Blade = Art.-Nr./Item no. 36433  
Abweiser/Deflector = Art.-Nr./Item no. 37133

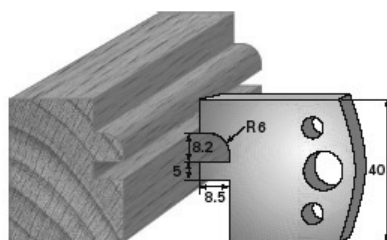

SP-Messer/Blade = Art.-Nr./Item no. 36134  
HS-Messer/Blade = Art.-Nr./Item no. 36434  
Abweiser/Deflector = Art.-Nr./Item no. 37134

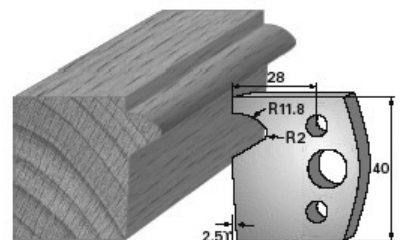

SP-Messer/Blade = Art.-Nr./Item no. 36135  
HS-Messer/Blade = Art.-Nr./Item no. 36435  
Abweiser/Deflector = Art.-Nr./Item no. 37135

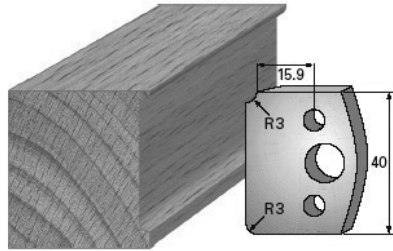

SP-Messer/Blade = Art.-Nr./Item no. 36170  
HS-Messer/Blade = Art.-Nr./Item no. 36470  
Abweiser/Deflector = Art.-Nr./Item no. 37170

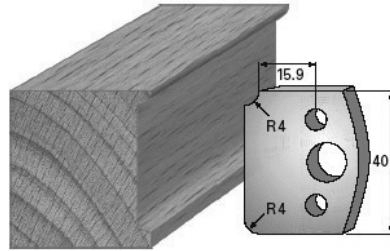

SP-Messer/Blade = Art.-Nr./Item no. 36171  
HS-Messer/Blade = Art.-Nr./Item no. 36471  
Abweiser/Deflector = Art.-Nr./Item no. 37171

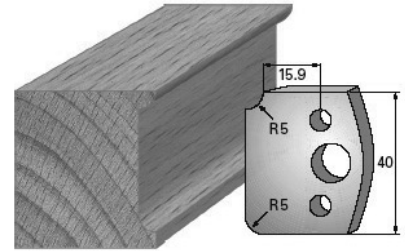

SP-Messer/Blade = Art.-Nr./Item no. 36172  
HS-Messer/Blade = Art.-Nr./Item no. 36472  
Abweiser/Deflector = Art.-Nr./Item no. 37172

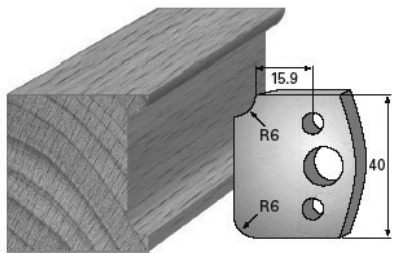

SP-Messer/Blade = Art.-Nr./Item no. 36173  
HS-Messer/Blade = Art.-Nr./Item no. 36473  
Abweiser/Deflector = Art.-Nr./Item no. 37173

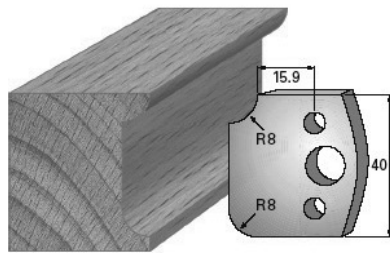

SP-Messer/Blade = Art.-Nr./Item no. 36174  
HS-Messer/Blade = Art.-Nr./Item no. 36474  
Abweiser/Deflector = Art.-Nr./Item no. 37174

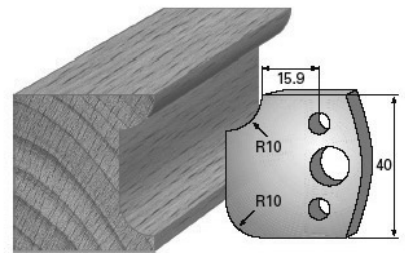

SP-Messer/Blade = Art.-Nr./Item no. 36175  
HS-Messer/Blade = Art.-Nr./Item no. 36475  
Abweiser/Deflector = Art.-Nr./Item no. 37175

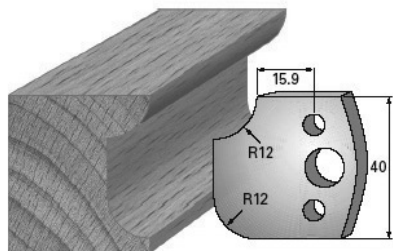

SP-Messer/Blade = Art.-Nr./Item no. 36176  
HS-Messer/Blade = Art.-Nr./Item no. 36476  
Abweiser/Deflector = Art.-Nr./Item no. 37176

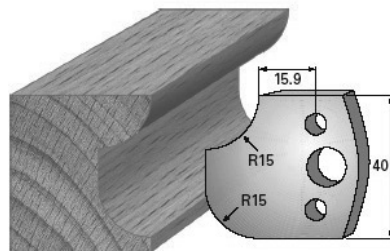

SP-Messer/Blade = Art.-Nr./Item no. 36177  
HS-Messer/Blade = Art.-Nr./Item no. 36477  
Abweiser/Deflector = Art.-Nr./Item no. 37177



MULTI-PROFIL **System** 40 mm („EURO-System“-kompatibel)  
40 mm (compatible with EURO-system)

**NEU**



MAN

**Ausführung:**

Das **MULTI-PROFIL**-Messer-System besteht aus jeweils profilierter Trägerplatte + profilierter Schneidplatte (HW oder HS-Qualität) + profilierter Abweiserplatte.

Achtung: lt. BG-Vorschrift erfolgt Abgabe stets satzweise bzw. paarweise!!

Das System ist im eingebauten Zustand form- und kraftschlüssig, rückschlagarm, in Verbindung mit Abweiserplatten für Handvorschubarbeiten, ansonsten jedoch auch für mech. Vorschub und CNC-Einsatz geeignet.

Alle Schneidplatten sind grundsätzlich seitlich hinterschliften!

**Das Messer-System passt ohne Änderungen in alle handelsübliche UNI-Profil-Messerköpfe „Euro-System“!**

**Anwendung:**

Vorwiegend zum Profilieren von

- a) HS-Qualität = Weich und Harthölzern
- b) HW-Qualität = Abrasivstoffen wie Corian, MDF, Multiplex und anderen Verbundstoffen/Leimhölzern geeignet.

**Profilmesser; Trägerplatten und Abweiser sind stets paarweise einzusetzen.**

**Abbildungen der lieferbaren Profile siehe**

**BRÜCK-Katalog 2008**

**Produktgruppe 6; Seiten 6.4 - 6.16**

**Design:**

The **MULTI-PROFILING** system consists of a profiled blade holder + profiled blade (TC or HSS) each.

Attention: Blades and deflectors have to be used in pairs !!

This system has a form- and force-locked tension, reduced recoil, in combination with deflectors preferably for manual feed. Otherwise also usable for mec. feed and operation on CNC machines.

All blades have a laterally relief-ground.

**This system is usable for all customary UNIVERSAL cutter heads, "EURO-system", without any changes.**

**Application:**

Mainly used for profiling

- a) HSS-quality = soft- and hard woods
- b) TC-quality = abrasive materials like Corian, MDF, Multiplex, other boards or glued woods.

**Profiling blades, blade holders and deflectors to be used in pairs.**

**Pictures of all available profiles are shown in our catalogue 2008**

**product group 6, page 6.4 - 6.16**

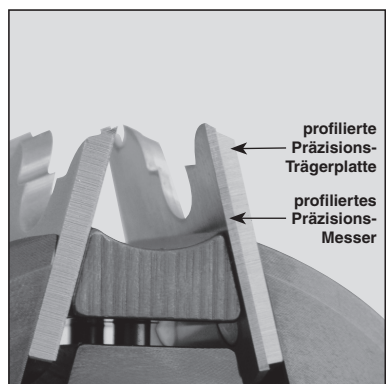
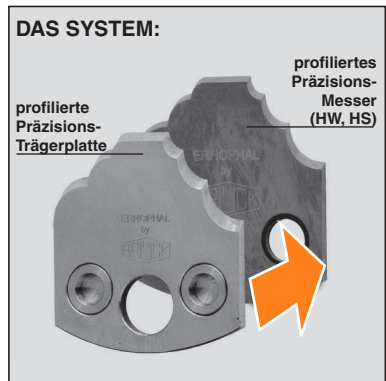

**Standardprofile/Standard Profiles**

Artikel-Nr. Item no.	Bezeichnung Description	Profil-Nr. profile no.	Netto/net EURO Stck./pce
35000HW – 35131HW	Profil-Messer <b>HW-Qualität</b> /profiling blade <b>TC-quality</b>	0 – 131	82,70
36000HS – 36131HS	Profil-Messer <b>HS-Qualität</b> /profiling blade <b>HSS-quality</b>	0 – 131	20,70
37000TP – 37131TP	Profil-Trägerplatten/profile blade holder	0 – 131	21,00
37000A – 37131A	Profil-Abweiser/profile deflector	0 – 131	4,80
35000HWS – 35131HWS	Kompl. <b>HW</b> -Profilmessersatz best. aus: 2 Messern, 2 Trägerplatten und 2 Abweisern Complete <b>TC</b> -profile blade set consists of: 2 blades, 2 blade holders and 2 deflectors	0 – 131	184,00
36000HSS – 36131HSS	Kompl. <b>HS</b> -Profilmessersatz wie vor Complete <b>HSS</b> -profiling blade set, like before	0 – 131	78,00
35000START – 35131START	STARTER-SET best. aus: je 2 <b>HW</b> + <b>HS</b> -Profilmessern, 2 Trägerplatten und 2 Abweisern STARTER-SET consists of: 2 <b>TC</b> + <b>HSS</b> -profiling blades, 2 blade holders and 2 deflectors each	0 – 131	203,50

**Sonderprofile/Special Profiles**

Profilgruppe profile category	Artikel-Nr./Item no. HW-Qualität/TC-quality	Netto/net EURO Stck./pce HW/TC	Artikel-Nr./Item no. HS-Qualität/HSS-quality	Netto/net EURO Stck./pce HS/HSS
A) kompl. Satz bestehend aus: jeweils 2 Messern, 2 Trägerplatten und 2 Abweisern A) complete set consists of: 2 blades, 2 blade holders and 2 deflectors each				
1	35001HWS-SO	224,00/Satz/set	36001HSS-SO	136,40/Satz/set
2	35002HWS-SO	236,00/Satz/set	36002HSS-SO	150,90/Satz/set
3	35003HWS-SO	255,00/Satz/set	36003HSS-SO	171,60/Satz/set
B) Nachbestellung pro Paar Ersatzmesser B) repeat order/price for one pair replacement blades				
1	35001HW-SO	169,00/Paar/pair	36001HS-SO	66,80/Paar/pair
2	35002HW-SO	174,00/Paar/pair	36002HS-SO	71,20/Paar/pair
3	35003HW-SO	185,00/Paar/pair	36003HS-SO	83,10/Paar/pair
HW-Messersatz-Blanketts (2x Messer & 2x Abweiser)	35900HWS	Auf Anfrage / on request		

MULTI-PROFIL System 50 mm („EURO-System“-kompatibel)  
50 mm (compatible with EURO-system)

**NEU**



## Standardprofile/Standard Profiles

Artikel-Nr. Item no.	Bezeichnung Description	Profil-Nr. profile no.	Netto/net EURO Stck./pce
38500HW – 38580HW	Profil-Messer <b>HW-Qualität</b> /profiling blade <b>TC-quality</b>	0 – 80	107,60
36500HS – 36580HS	Profil-Messer <b>HS-Qualität</b> /profiling blade <b>HSS-quality</b>	0 – 80	26,80
37500TP – 37580TP	Profil-Trägerplatten/profile blade holder	0 – 80	27,30
39000A – 39580A	Profil-Abweiser/profile deflector	0 – 80	5,70
38500HWS – 38580HWS	Kompl. <b>HW</b> -Profilmessersatz best. aus: 2 Messern, 2 Trägerplatten und 2 Abweisern <i>Complete TC-profile blade set consists of: 2 blades, 2 blade holders and 2 deflectors</i>	0 – 80	245,00
36500HSS – 36580HSS	Kompl. <b>HS</b> -Profilmessersatz wie vor <i>Complete HSS-profiling blade set, like before</i>	0 – 80	102,30
38500START – 38580START	STARTER-SET best. aus: je 2 <b>HW</b> + <b>HS</b> -Profilmessern, 2 Trägerplatten und 2 Abweisern <i>STARTER-SET consists of: 2 TC + HSS-profiling blades, 2 blade holders and 2 deflectors each</i>	0 – 80	271,00

## Sonderprofile/Special Profiles

Profilgruppe profile category	Artikel-Nr./Item no. HW-Qualität/TC-quality	Netto/net EURO Stck./pce HW/TC	Artikel-Nr./Item no. HS-Qualität/HSS-quality	Netto/net EURO Stck./pce HS/HSS
----------------------------------	--	--------------------------------------	---	---------------------------------------

A) kompl. Satz bestehend aus: jeweils 2 Messern, 2 Trägerplatten und 2 Abweisern  
A) complete set consists of: 2 blades, 2 blade holders and 2 deflectors each

1	38501HWS-SO	286,00/Satz/set	36501HSS-SO	172,00/Satz/set
2	38502HWS-SO	305,00/Satz/set	36502HSS-SO	190,00/Satz/set
3	38503HWS-SO	327,00/Satz/set	36503HSS-SO	217,00/Satz/set

B) Nachbestellung pro Paar Ersatzmesser  
B) repeat order/price for one pair replacement blades

1	38501HW-SO	216,00/Paar/pair	36501HS-SO	86,00/Paar/pair
2	38502HW-SO	223,00/Paar/pair	36502HS-SO	90,00/Paar/pair
3	38503HW-SO	236,00/Paar/pair	36503HS-SO	105,00/Paar/pair

HW-Messersatz-Blanketts  
(2x Messer & 2x Abweiser)

Auf Anfrage/ on request

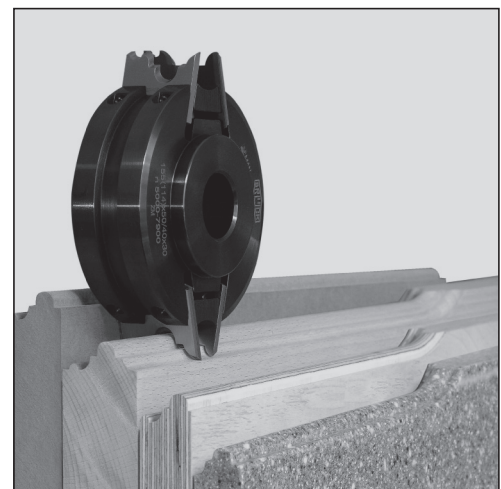
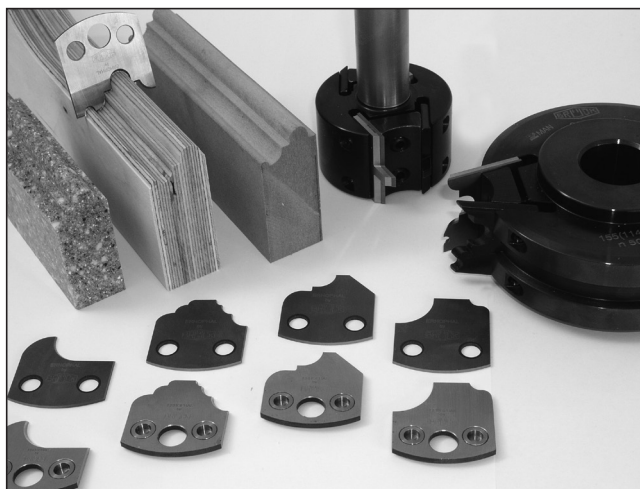

## UNIVERSAL-Profilmesserkopf Z 2

50 x 4 mm – EURO-System

### UNIVERSAL head for profiling blades Z 2

50 x 4 mm – EURO system



#### Ausführung:

Werkzeugkörper aus Stahl, spandickenbegrenzt, rückschlagarm, vorzugsweise für Handvorschubarbeiten. Formschlüssige Messer- und Abweiserbefestigung auf konstanten Flugkreis.

Profilmesser aus **SP-Stahl und HS-Stahl**, seitlich hinterschleifen lieferbar!

Grundwerkzeug wird mit 40 mm Falzmesser in SP-Stahl bestückt geliefert!

Max. Profiltiefe 17 mm

#### Design:

Universal head for profiling blades, chip-thickness limitation, reduced recoil, preferably for manual feed. Tool made from steel. Positive blade and deflector fastening with constant cutting circle.

Profiling blades with lateral set-off. Blades made from special steel and high-speed steel.

Basic tool incl. rabbeting blade in special steel.

max. profile depth 17 mm

#### Anwendung:

Vorwiegend zum Profilieren von Weich- und Harthölzern (Vollholz unverleimt).

**Profilmesser mit den jeweils passenden Abweisern sind stets paarweise einzusetzen.**

#### Application:

Preferably for soft- and hard-textured wood (unglued solid wood).

**Profiling blades and the corresponding deflector plates to be used in pairs.**

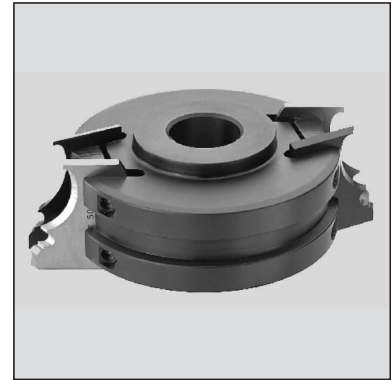

Art.-Nr./Item no. 3910

Abb. der lieferbaren Profile siehe folgende Seiten.

For illustrations of the available profiles, see separate list!

### NEU

Alle Standard-Profile und Sonder-Profile 40 + 50 mm ab sofort auch in

#### **HARTMETALL (HW)-Qualität**

als MULTI-PROFIL-System lieferbar!

Preise und Details siehe Seiten 6.17 + 6.18

### NEW

All standard-profiles and special-profiles 40 + 50 mm also available as MULTI-PROFIL-System in

#### **TUNGSTEN-CARBIDE (TC)-quality**

Prices and details please see pages 6.17 + 6.18

Artikel-Nr. Item no.	Abmessung mm Dimensions mm D/D B/W d/b	Z	Ausführung Quality	n/min <sup>-1</sup>	EURO Stck./pce
3910	114 x 40/50 x 30	2	Stahl/Steel	5100 – 7900	138,00
3911	114 x 40/50 x 40	2	Stahl/Steel	5100 – 7900	138,00

Neben den unten genannten Profilmessern 50 mm können alle UNI-Profilmesser 40 mm – EURO-System – eingesetzt werden.

Besides the profiling blades 50 mm listed below, any UNI profiling blade 40 mm – EURO system – can be used

### Profilmesser und Abweiser (Abgabe ausschl. paarweise) Profiling blades and deflectors (only in pairs)

Artikel-Nr. Item no.	Bezeichnung Description	Profil-Nr. Profile	EURO Stck./pce
38500 – 38519	UNI-Profilmesser 50 x 4 mm SP-Stahl/UNI Profiling blade 50 x 4 mm special steel	500 – 519	14,70
38520 – 38524	UNI-Profilmesser 50 x 4 mm SP-Stahl/UNI Profiling blade 50 x 4 mm special steel	520 – 524	23,20
38541 – 38580	UNI-Profilmesser 50 x 4 mm SP-Stahl/UNI Profiling blade 50 x 4 mm special steel	541 – 580	14,70
36500 – 36580	UNI-Profilmesser 50 x 4 mm HS-Stahl/UNI Profiling blade 50 x 4 mm HS	500 – 580	32,40
39500 – 39580	Abweiser 48 mm/Deflector 48 mm	500 – 580	12,90
36903	Blankett 50 x 4 mm – HS/Blank 50 x 4 mm – HS		23,70
37306	Blankett 48 x 4 mm – Abweiser/Deflector 48 x 4 mm		12,90

## UNI-Profil- und Falzmesserkopf Z 2

mit Vorschneider u. HW-WP-Bestückung 40 x 12 x 1,5 mm

### Universal profiling- and rebating head Z 2

with TC-roughing tooth and TC-reversible blades 40 x 12 x 1,5 mm



#### Ausführung:

Werkzeugkörper aus hochfestem Leichtmetall mit Eloxalbeschichtung bei **3590**, Werkzeugkörper aus Stahl bei **3912** (f. 40/50 mm UNI-Profilmesser) spandickenbegrenzt, rückschlagarm, vorzugsweise für Handvorschubarbeiten.

Bestückt mit Messerhalter f. HW-WP, HW-WP 40 x 12 x 1,5 mm, Abweiser und HW-Vorschneider 14 x 14 x 2,0 mm

**Ansonsten sind alle UNI-Profilmesser 40 x 4 mm und 50 x 4 mm (EURO-System) einsetzbar!**

(s.Katalog PG 6 – Seiten 6.4 – 6.21)

#### Design:

**3590:** Tool made from light metal with high tensile strength, anodised coated. **3912** (for 40/50 mm Uni-profiling blades). Body made from steel, chip thickness limitation, reduced recoil, preferably for manual feed.

Fit with blade holder for TC-reversible blades 40 x 12 x 1,5 mm, deflector and TC-roughing tooth 14 x 14 x 2,0 mm

**Otherwise all UNI-profiling blades 40 x 4 mm and 50 x 4 mm (EURO-system) are usable!**

(see catalogue PG 6 – page 6.4 – 6.21)



Art.-Nr./Item no. 3912

#### Anwendung:

Zum Falzen von Plattenwerkstoffen wie Sperrholz und Tischler-, Span- und Hartfaserplatten mit und ohne Kunststoffbeschichtung oder Furnier, verleimten Hölzern sowie zum Profilieren von Massivhölzern. Die Profilmesser 40 x 4 bzw. 50 x 4 mm und Abweiser sind stets profiltgleich paarweise einzusetzen.

#### Application:

For rebating boards with or without veneer or plastic coating, modified and high-density wood, glued solid wood and also for profiling solid woods. The profiling blades 40 x 4 mm and 50 x 4 mm and deflectors have to be used in pairs.

Artikel-Nr. Item no.	Bezeichnung Description	Abmessungen in mm Dimensions in mm	Schneiden Cutting	n/min-1	EURO Stck./pce
3590	UNI-Profil- und Falzmesserkopf kpl. m. HW-Vorschneider u. HW-WP UNI-profiling- and rebating cutter head with TC-roughing tooth and TC-reversible blades	98 x 40 x 30	Z2/V2	5800-9000	171,00
3912	UNI-Profil- und Falzmesserkopf kpl. m. HW-Vorschneider u. HW-WP UNI-profiling- and rebating cutter head with TC-roughing tooth and TC-reversible blades	117 x 40/50 x 30	Z2/V2	5000-7900	205,00

## Ersatz-Wendeplatten für UNI-Profil- und Falzmesserkopf 3590/3912

### Replacement parts for UNI-profiling- and rebating cutter head 3590/3912

Artikel-Nr. Item no.	Bezeichnung Description	EURO Stck./pce
01040012	HW-Wendeplatte 40 x 12 x 1,5 mm TC-reversible blade 40 x 12 x 1,5 mm	4,10
01014142	HW-Vorschneider 14 x 14 x 2,0 mm TC-roughing tooth 14 x 14 x 2,0 mm	3,00

Sonderleistung wie z.B. andere Bohrungen – auf Anfrage.  
Andere Abmessungen und Ausführungen – auf Anfrage.

Verpackungseinheit für Ersatzplatten: 10 Stück

Extras such as different bores upon request.  
Other dimensions and designs upon request.

Packing quantities for replacement bands: 10 pcs

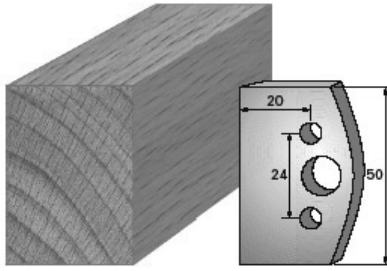

SP-Messer/Blade = Art.-Nr./Item no. 38500  
HS-Messer/Blade = Art.-Nr./Item no. 36500  
Abweiser/Deflector = Art.-Nr./Item no. 39500

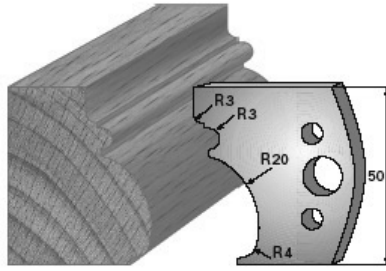

SP-Messer/Blade = Art.-Nr./Item no. 38501  
HS-Messer/Blade = Art.-Nr./Item no. 36501  
Abweiser/Deflector = Art.-Nr./Item no. 39501

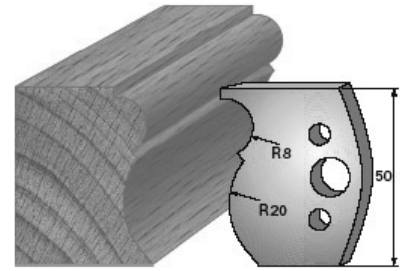

SP-Messer/Blade = Art.-Nr./Item no. 38502  
HS-Messer/Blade = Art.-Nr./Item no. 36502  
Abweiser/Deflector = Art.-Nr./Item no. 39502

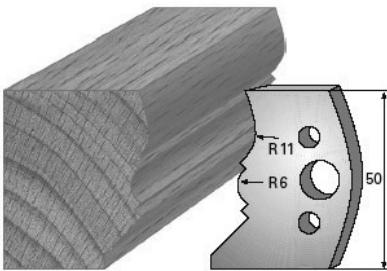

SP-Messer/Blade = Art.-Nr./Item no. 38503  
HS-Messer/Blade = Art.-Nr./Item no. 36503  
Abweiser/Deflector = Art.-Nr./Item no. 39503

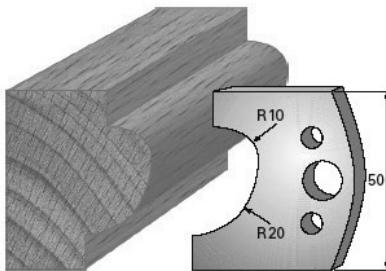

SP-Messer/Blade = Art.-Nr./Item no. 38504  
HS-Messer/Blade = Art.-Nr./Item no. 36504  
Abweiser/Deflector = Art.-Nr./Item no. 39504

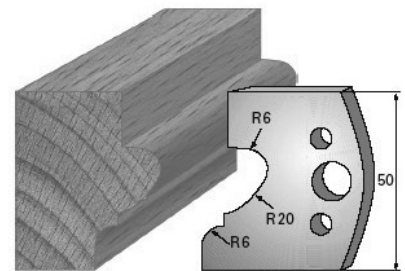

SP-Messer/Blade = Art.-Nr./Item no. 38505  
HS-Messer/Blade = Art.-Nr./Item no. 36505  
Abweiser/Deflector = Art.-Nr./Item no. 39505

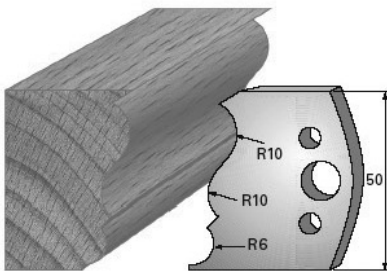

SP-Messer/Blade = Art.-Nr./Item no. 38506  
HS-Messer/Blade = Art.-Nr./Item no. 36506  
Abweiser/Deflector = Art.-Nr./Item no. 39506

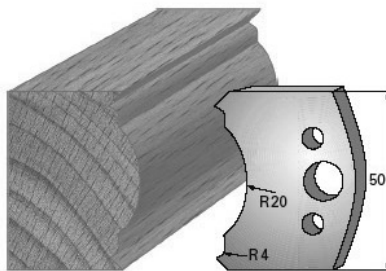

SP-Messer/Blade = Art.-Nr./Item no. 38507  
HS-Messer/Blade = Art.-Nr./Item no. 36507  
Abweiser/Deflector = Art.-Nr./Item no. 39507

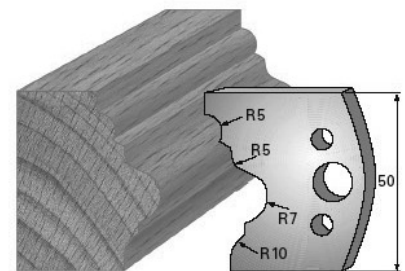

SP-Messer/Blade = Art.-Nr./Item no. 38508  
HS-Messer/Blade = Art.-Nr./Item no. 36508  
Abweiser/Deflector = Art.-Nr./Item no. 39508

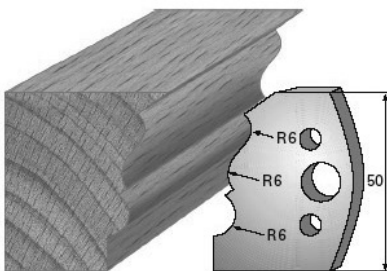

SP-Messer/Blade = Art.-Nr./Item no. 38509  
HS-Messer/Blade = Art.-Nr./Item no. 36509  
Abweiser/Deflector = Art.-Nr./Item no. 39509

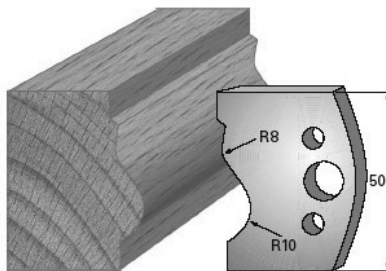

SP-Messer/Blade = Art.-Nr./Item no. 38510  
HS-Messer/Blade = Art.-Nr./Item no. 36510  
Abweiser/Deflector = Art.-Nr./Item no. 39510

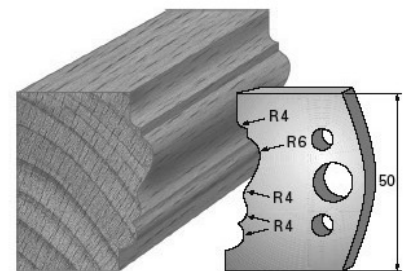

SP-Messer/Blade = Art.-Nr./Item no. 38511  
HS-Messer/Blade = Art.-Nr./Item no. 36511  
Abweiser/Deflector = Art.-Nr./Item no. 39511

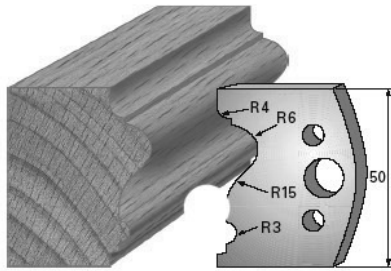

SP-Messer/Blade = Art.-Nr./Item no. 38512  
HS-Messer/Blade = Art.-Nr./Item no. 36512  
Abweiser/Deflector = Art.-Nr./Item no. 39512

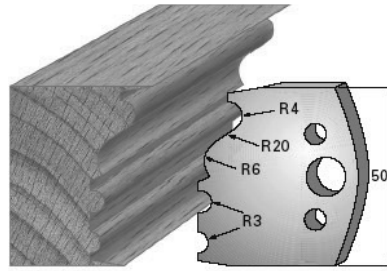

SP-Messer/Blade = Art.-Nr./Item no. 38513  
HS-Messer/Blade = Art.-Nr./Item no. 36513  
Abweiser/Deflector = Art.-Nr./Item no. 39513

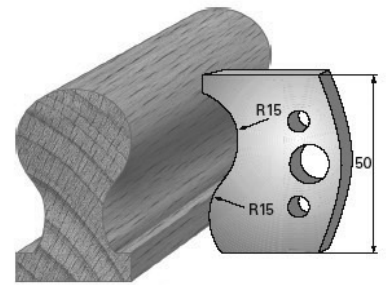

SP-Messer/Blade = Art.-Nr./Item no. 38514  
HS-Messer/Blade = Art.-Nr./Item no. 36514  
Abweiser/Deflector = Art.-Nr./Item no. 39514

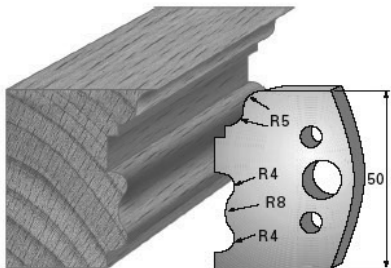

SP-Messer/Blade = Art.-Nr./Item no. 38515  
HS-Messer/Blade = Art.-Nr./Item no. 36515  
Abweiser/Deflector = Art.-Nr./Item no. 39515

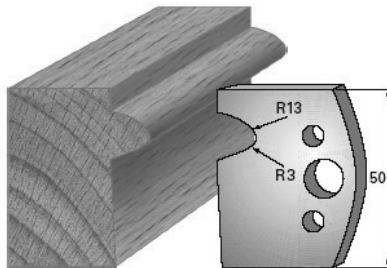

SP-Messer/Blade = Art.-Nr./Item no. 38516  
HS-Messer/Blade = Art.-Nr./Item no. 36516  
Abweiser/Deflector = Art.-Nr./Item no. 39516

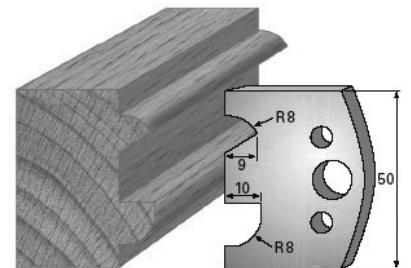

SP-Messer/Blade = Art.-Nr./Item no. 38517  
HS-Messer/Blade = Art.-Nr./Item no. 36517  
Abweiser/Deflector = Art.-Nr./Item no. 39517

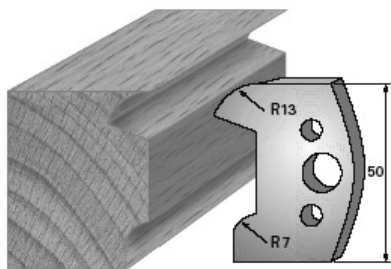

SP-Messer/Blade = Art.-Nr./Item no. 38518  
HS-Messer/Blade = Art.-Nr./Item no. 36518  
Abweiser/Deflector = Art.-Nr./Item no. 39518

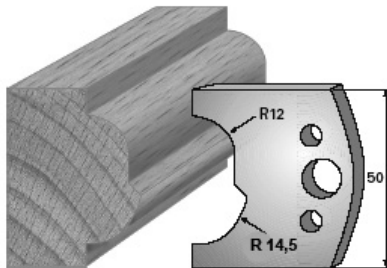

SP-Messer/Blade = Art.-Nr./Item no. 38519  
HS-Messer/Blade = Art.-Nr./Item no. 36519  
Abweiser/Deflector = Art.-Nr./Item no. 39519

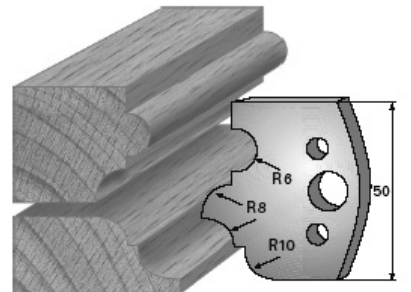

SP-Messer/Blade = Art.-Nr./Item no. 38520  
HS-Messer/Blade = Art.-Nr./Item no. 36520  
Abweiser/Deflector = Art.-Nr./Item no. 39520

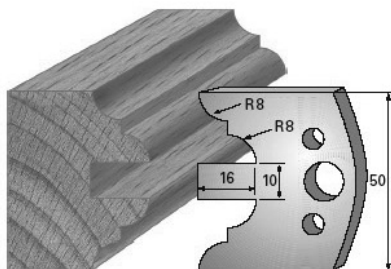

SP-Messer/Blade = Art.-Nr./Item no. 38522  
HS-Messer/Blade = Art.-Nr./Item no. 36522  
Abweiser/Deflector = Art.-Nr./Item no. 39522

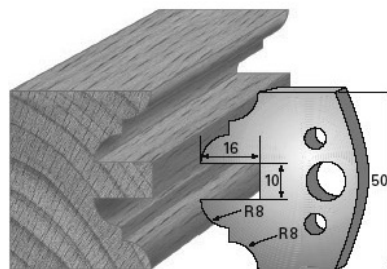

SP-Messer/Blade = Art.-Nr./Item no. 38523  
HS-Messer/Blade = Art.-Nr./Item no. 36523  
Abweiser/Deflector = Art.-Nr./Item no. 39523

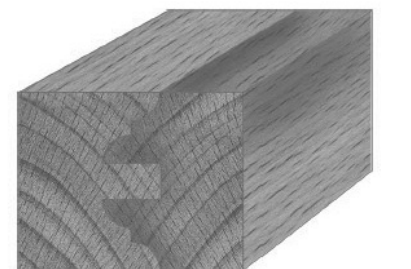

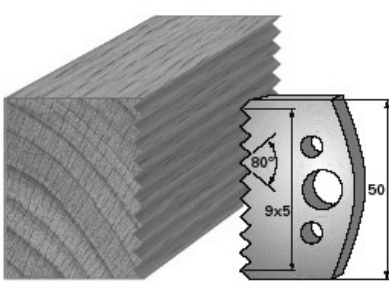

SP-Messer/Blade = Art.-Nr./Item no. 38524  
HS-Messer/Blade = Art.-Nr./Item no. 36524  
Abweiser/Deflector = Art.-Nr./Item no. 39524

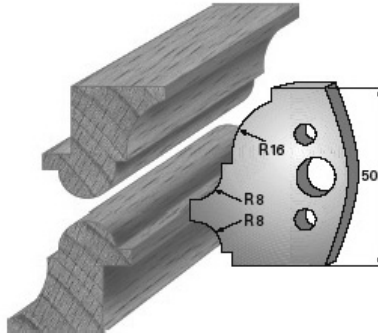

SP-Messer/Blade = Art.-Nr./Item no. 38541  
HS-Messer/Blade = Art.-Nr./Item no. 36541  
Abweiser/Deflector = Art.-Nr./Item no. 39541

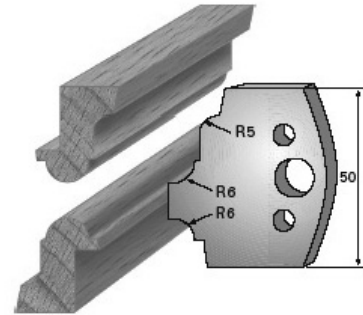

SP-Messer/Blade = Art.-Nr./Item no. 38542  
HS-Messer/Blade = Art.-Nr./Item no. 36542  
Abweiser/Deflector = Art.-Nr./Item no. 39542

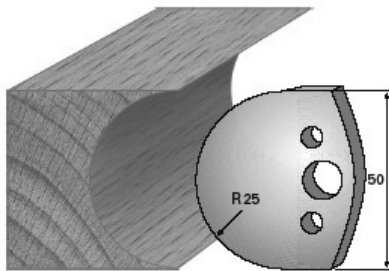

SP-Messer/Blade = Art.-Nr./Item no. 38543  
HS-Messer/Blade = Art.-Nr./Item no. 36543  
Abweiser/Deflector = Art.-Nr./Item no. 39543

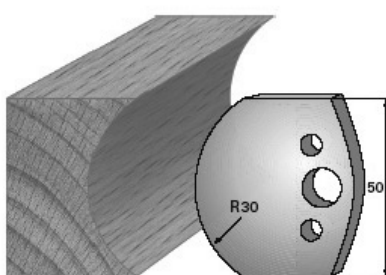

SP-Messer/Blade = Art.-Nr./Item no. 38544  
HS-Messer/Blade = Art.-Nr./Item no. 36544  
Abweiser/Deflector = Art.-Nr./Item no. 39544

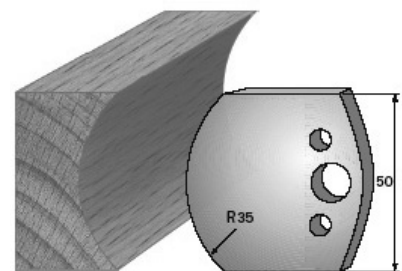

SP-Messer/Blade = Art.-Nr./Item no. 38545  
HS-Messer/Blade = Art.-Nr./Item no. 36545  
Abweiser/Deflector = Art.-Nr./Item no. 39545

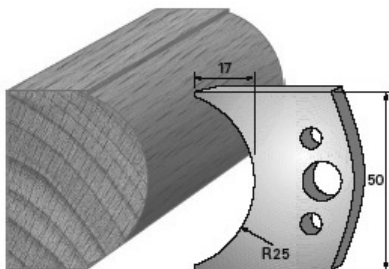

SP-Messer/Blade = Art.-Nr./Item no. 38546  
HS-Messer/Blade = Art.-Nr./Item no. 36546  
Abweiser/Deflector = Art.-Nr./Item no. 39546

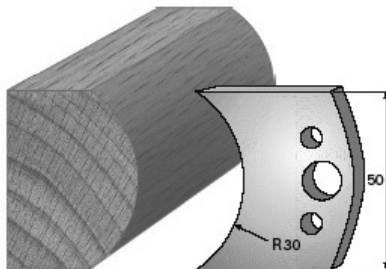

SP-Messer/Blade = Art.-Nr./Item no. 38547  
HS-Messer/Blade = Art.-Nr./Item no. 36547  
Abweiser/Deflector = Art.-Nr./Item no. 39547

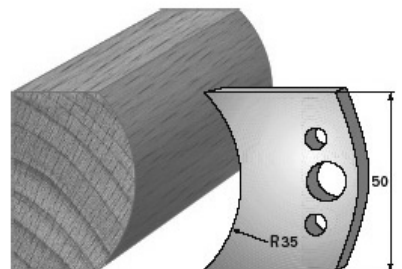

SP-Messer/Blade = Art.-Nr./Item no. 38548  
HS-Messer/Blade = Art.-Nr./Item no. 36548  
Abweiser/Deflector = Art.-Nr./Item no. 39548

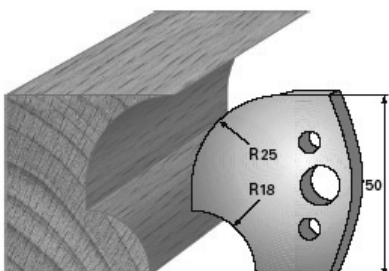

SP-Messer/Blade = Art.-Nr./Item no. 38549  
HS-Messer/Blade = Art.-Nr./Item no. 36549  
Abweiser/Deflector = Art.-Nr./Item no. 39549

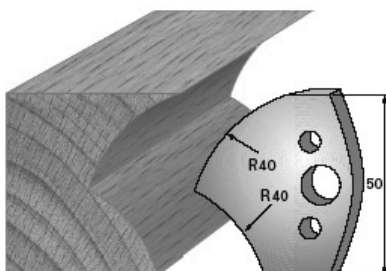

SP-Messer/Blade = Art.-Nr./Item no. 38550  
HS-Messer/Blade = Art.-Nr./Item no. 36550  
Abweiser/Deflector = Art.-Nr./Item no. 39550

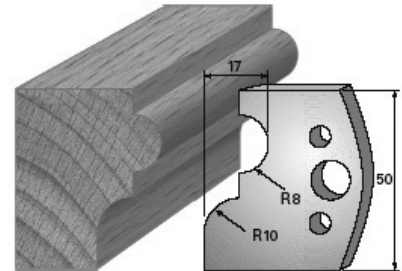

SP-Messer/Blade = Art.-Nr./Item no. 38551  
HS-Messer/Blade = Art.-Nr./Item no. 36551  
Abweiser/Deflector = Art.-Nr./Item no. 39551

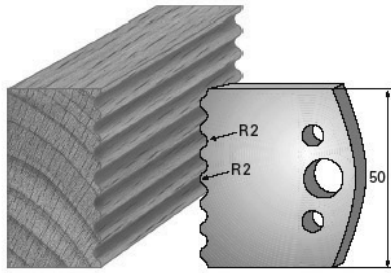

SP-Messer/Blade = Art.-Nr./Item no. 38552  
HS-Messer/Blade = Art.-Nr./Item no. 36552  
Abweiser/Deflector = Art.-Nr./Item no. 39552

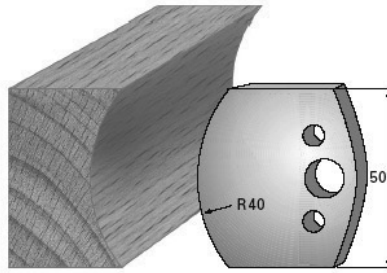

SP-Messer/Blade = Art.-Nr./Item no. 38553  
HS-Messer/Blade = Art.-Nr./Item no. 36553  
Abweiser/Deflector = Art.-Nr./Item no. 39553

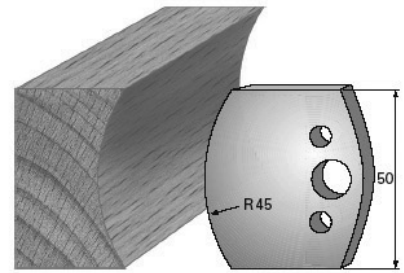

SP-Messer/Blade = Art.-Nr./Item no. 38554  
HS-Messer/Blade = Art.-Nr./Item no. 36554  
Abweiser/Deflector = Art.-Nr./Item no. 39554

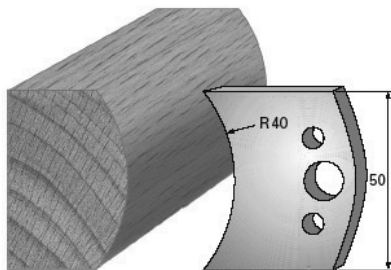

SP-Messer/Blade = Art.-Nr./Item no. 38555  
HS-Messer/Blade = Art.-Nr./Item no. 36555  
Abweiser/Deflector = Art.-Nr./Item no. 39555

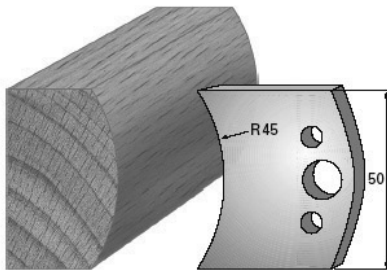

SP-Messer/Blade = Art.-Nr./Item no. 38556  
HS-Messer/Blade = Art.-Nr./Item no. 36556  
Abweiser/Deflector = Art.-Nr./Item no. 39556

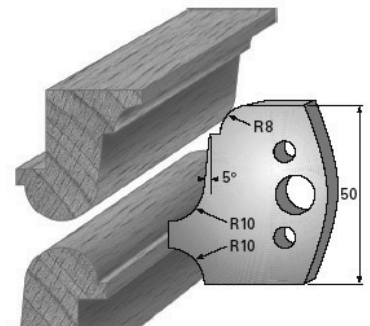

SP-Messer/Blade = Art.-Nr./Item no. 38557  
HS-Messer/Blade = Art.-Nr./Item no. 36557  
Abweiser/Deflector = Art.-Nr./Item no. 39557

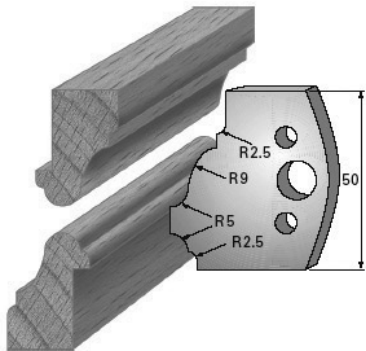

SP-Messer/Blade = Art.-Nr./Item no. 38558  
HS-Messer/Blade = Art.-Nr./Item no. 36558  
Abweiser/Deflector = Art.-Nr./Item no. 39558



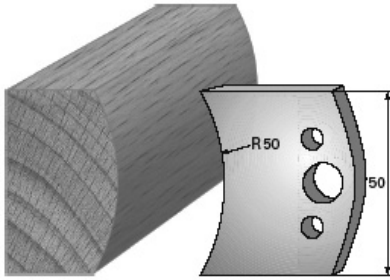

SP-Messer/Blade = Art.-Nr./Item no. 38559  
HS-Messer/Blade = Art.-Nr./Item no. 36559  
Abweiser/Deflector = Art.-Nr./Item no. 39559

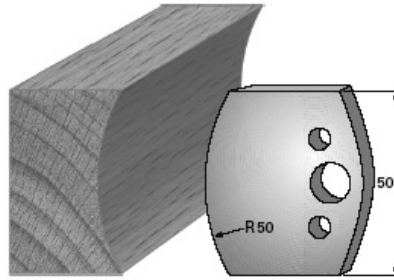

SP-Messer/Blade = Art.-Nr./Item no. 38560  
HS-Messer/Blade = Art.-Nr./Item no. 36560  
Abweiser/Deflector = Art.-Nr./Item no. 39560

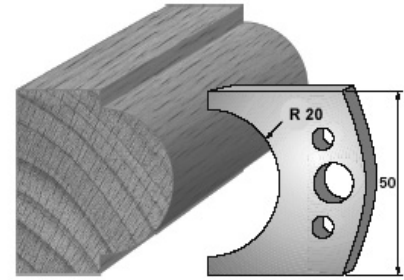

SP-Messer/Blade = Art.-Nr./Item no. 38561  
HS-Messer/Blade = Art.-Nr./Item no. 36561  
Abweiser/Deflector = Art.-Nr./Item no. 39561

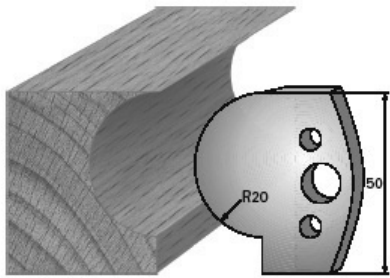

SP-Messer/Blade = Art.-Nr./Item no. 38562  
HS-Messer/Blade = Art.-Nr./Item no. 36562  
Abweiser/Deflector = Art.-Nr./Item no. 39562

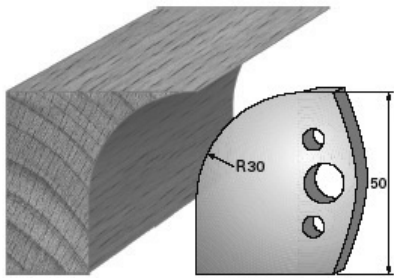

SP-Messer/Blade = Art.-Nr./Item no. 38563  
HS-Messer/Blade = Art.-Nr./Item no. 36563  
Abweiser/Deflector = Art.-Nr./Item no. 39563

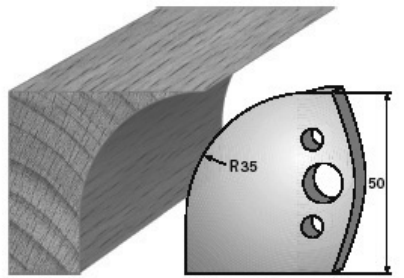

SP-Messer/Blade = Art.-Nr./Item no. 38564  
HS-Messer/Blade = Art.-Nr./Item no. 36564  
Abweiser/Deflector = Art.-Nr./Item no. 39564

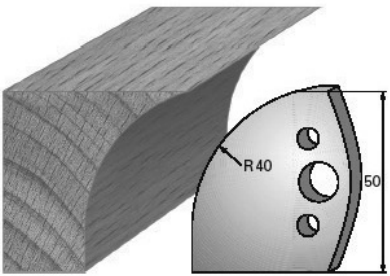

SP-Messer/Blade = Art.-Nr./Item no. 38565  
HS-Messer/Blade = Art.-Nr./Item no. 36565  
Abweiser/Deflector = Art.-Nr./Item no. 39565

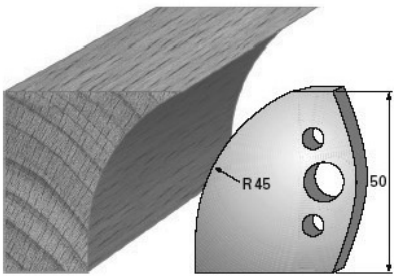

SP-Messer/Blade = Art.-Nr./Item no. 38566  
HS-Messer/Blade = Art.-Nr./Item no. 36566  
Abweiser/Deflector = Art.-Nr./Item no. 39566

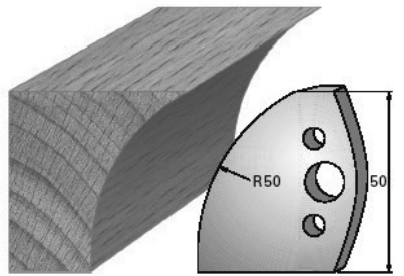

SP-Messer/Blade = Art.-Nr./Item no. 38567  
HS-Messer/Blade = Art.-Nr./Item no. 36567  
Abweiser/Deflector = Art.-Nr./Item no. 39567

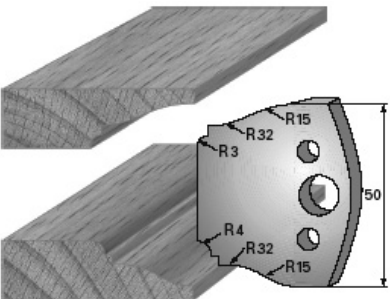

SP-Messer/Blade = Art.-Nr./Item no. 38568  
HS-Messer/Blade = Art.-Nr./Item no. 36568  
Abweiser/Deflector = Art.-Nr./Item no. 39568

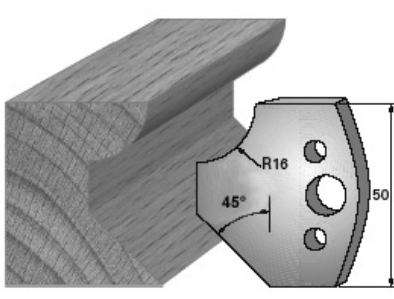

SP-Messer/Blade = Art.-Nr./Item no. 38569  
HS-Messer/Blade = Art.-Nr./Item no. 36569  
Abweiser/Deflector = Art.-Nr./Item no. 39569

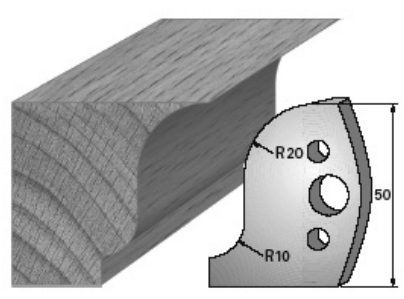

SP-Messer/Blade = Art.-Nr./Item no. 38570  
HS-Messer/Blade = Art.-Nr./Item no. 36570  
Abweiser/Deflector = Art.-Nr./Item no. 39570

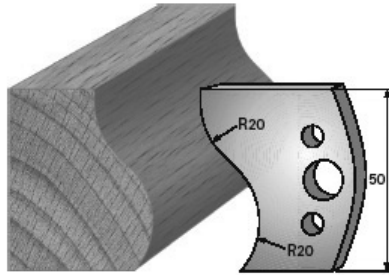

SP-Messer/Blade = Art.-Nr./Item no. 38571  
HS-Messer/Blade = Art.-Nr./Item no. 36571  
Abweiser/Deflector = Art.-Nr./Item no. 39571

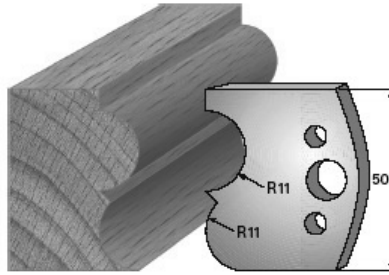

SP-Messer/Blade = Art.-Nr./Item no. 38572  
HS-Messer/Blade = Art.-Nr./Item no. 36572  
Abweiser/Deflector = Art.-Nr./Item no. 39572

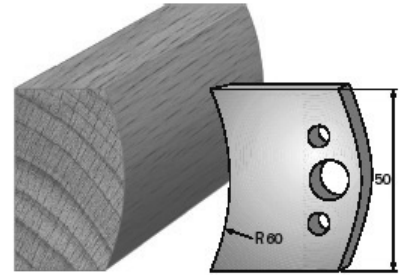

SP-Messer/Blade = Art.-Nr./Item no. 38573  
HS-Messer/Blade = Art.-Nr./Item no. 36573  
Abweiser/Deflector = Art.-Nr./Item no. 39573

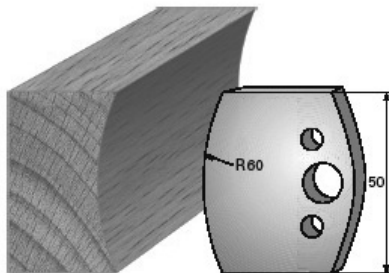

SP-Messer/Blade = Art.-Nr./Item no. 38574  
HS-Messer/Blade = Art.-Nr./Item no. 36574  
Abweiser/Deflector = Art.-Nr./Item no. 39574

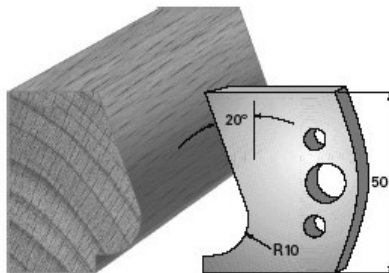

SP-Messer/Blade = Art.-Nr./Item no. 38575  
HS-Messer/Blade = Art.-Nr./Item no. 36575  
Abweiser/Deflector = Art.-Nr./Item no. 39575

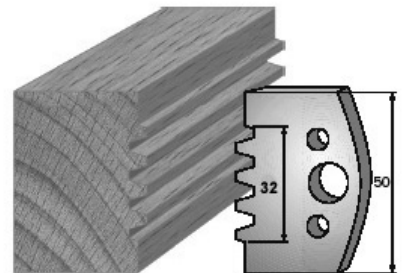

SP-Messer/Blade = Art.-Nr./Item no. 38576  
HS-Messer/Blade = Art.-Nr./Item no. 36576  
Abweiser/Deflector = Art.-Nr./Item no. 39576

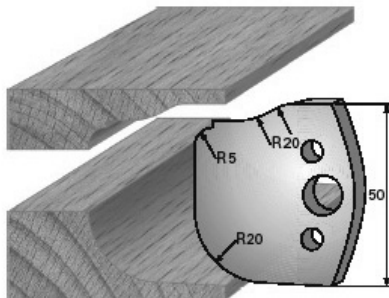

SP-Messer/Blade = Art.-Nr./Item no. 38577  
HS-Messer/Blade = Art.-Nr./Item no. 36577  
Abweiser/Deflector = Art.-Nr./Item no. 39577

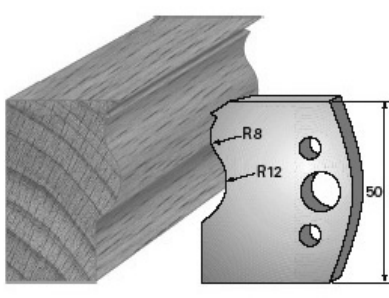

SP-Messer/Blade = Art.-Nr./Item no. 38578  
HS-Messer/Blade = Art.-Nr./Item no. 36578  
Abweiser/Deflector = Art.-Nr./Item no. 39578

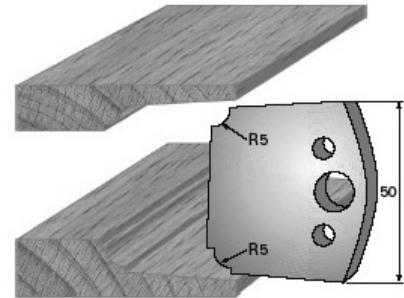

SP-Messer/Blade = Art.-Nr./Item no. 38579  
HS-Messer/Blade = Art.-Nr./Item no. 36579  
Abweiser/Deflector = Art.-Nr./Item no. 39579

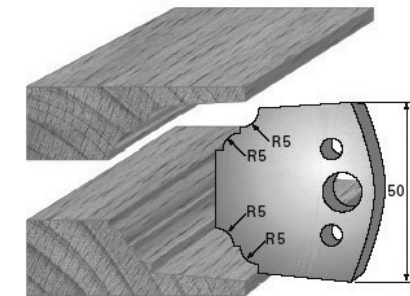

SP-Messer/Blade = Art.-Nr./Item no. 38580  
HS-Messer/Blade = Art.-Nr./Item no. 36580  
Abweiser/Deflector = Art.-Nr./Item no. 39580

# UNIVERSAL-Großprofiler-System

für Profilmesser 60/80 x 5,5 mm

**UNI large profiler system**

for profiling blades 60/80 x 5,5 mm



### Ausführung:

Werkzeugkörper aus Stahl, spandickenbegrenzt, rückschlagarm, vorzugsweise für Handvorschubarbeiten. Formschlüssige Messer- und Abweiserbefestigung auf konstanten Flugkreis.

Profilmesser aus **SP-Stahl** (nur 60 mm) und **HS-Stahl**, seitlich hinterschiffen lieferbar!

Max. Profiltiefe 27 mm

### Design:

*Tool made from steel, chip-thickness limitation, reduced recoil, preferably for manual feed. Positive blade and deflector fastening with constant cutting circle.*

*Profiling blades with special steel (only 60 mm) and high-speed steel, laterally reliefground.*

max. profile depth 27 mm

### Anwendung:

Vorwiegend zum Profilieren von Weich- und Harthölzern (Vollholz unverleimt).

**Profilmesser mit den jeweils passenden Abweisern sind stets paarweise einzusetzen.**

### Application:

*Preferably for soft- and hard-textured wood (unglued solid wood).*

**Profiling blades and the corresponding deflectors to be used in pairs.**

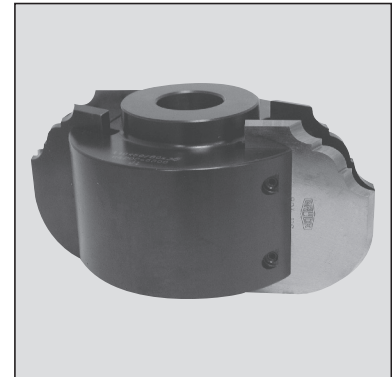

Art.-Nr./Item no. 3930



Art.-Nr./Item no. 3924

Abb. der lieferbaren Profile siehe folgende Seiten.  
For illustrations of the available profiles, see separate list!

Artikel-Nr. Item no.	Bezeichnung Description	n/min <sup>-1</sup>	EURO Stck./pce
3920	SOLO-Messerkopf 110 x 60 x 30 mm Z 2 (o. Messerbestückung) <i>SOLO head 110 x 60 x 30 mm Z 2 (without blades)</i>	4000 – 6000	197,00
3921	SOLO-Messerkopf 110 x 60 x 40 mm Z 2 (o. Messerbestückung) <i>SOLO head 110 x 60 x 40 mm Z 2 (without blades)</i>	4000 – 6000	197,00
3930	SOLO-Messerkopf 110 x 60/80 x 30 mm Z 2 (o. Messerbestückung) <i>SOLO head 110 x 60/80 x 30 mm Z 2 (without blades)</i>	4200 – 6000	239,00
3931	SOLO-Messerkopf 110 x 60/80 x 40 mm Z 2 (o. Messerbestückung) <i>SOLO head 110 x 60/80 x 40 mm Z 2 (without blades)</i>	4200 – 6000	286,00
3924	UNI-Großprofiler-Set kpl. m. 4 Profil- und Abweiserpaaren (SP-Stahl) (Profil 60004; 60008; 60011; 60021) inkl. Holzkassette <i>UNI large profiler set complete with 4 profile and deflector pairs (profiles no. 60004; 60008; 60011; 60021) incl. wooden box</i>		492,00

Artikel-Nr. Item no.	Bezeichnung Description	EURO Stck./pce
60000 – 60021	SP-Stahl Profilmesser 60 x 5,5 mm / <i>special steel profiling blade 60 x 5,5 mm</i>	22,20
62000 – 62021	HS-Stahl Profilmesser 60 x 5,5 mm / <i>high-speed steel profiling blade 60 x 5,5 mm</i>	60,30
61000 – 61021	Abweiser für dto. 58 x 5,3 mm / <i>deflector for ditto 58 x 5,3 mm</i>	17,90
62500	HS-Blankett 60 x 5,5 mm / <i>high-speed steel blank 60 x 5,5 mm</i>	43,20
61500	Abweiser Blankett / <i>deflector blank</i>	7,70
80001 – 80004	HS-Stahl Profilmesser 80 x 5,5 mm / <i>high-speed steel profiling blade 80 x 5,5 mm</i>	71,50
81001 – 81004	Abweiser für dto. 78 x 5,3 mm / <i>deflector for ditto 78 x 5,3 mm</i>	48,00
80500	HS-Blankett 80 x 5,5 mm / <i>high-speed steel blank 80 x 5,5 mm</i>	64,20
81500	Abweiser Blankett 78 x 5,3 mm / <i>deflector blank 78 x 5,3 mm</i>	33,10

- Sonderprofil-Preisgruppen siehe Seite 6.30
- Schärfpreise für Standard- und Sonderprofile siehe Seite 6.31
- Abgabe der Standard- und Sonderprofile immer satzweise.

- Price categories applicable to special profiles: please see page 6.30
- Prices of sharpening/standard and special profiles: please see page 6.31
- All standard and special profiles only available in pairs

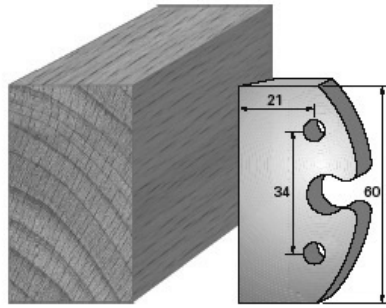

SP-Messer/Blade = Art.-Nr./Item no. 60000  
HS-Messer/Blade = Art.-Nr./Item no. 62000  
Abweiser/Deflector = Art.-Nr./Item no. 61000

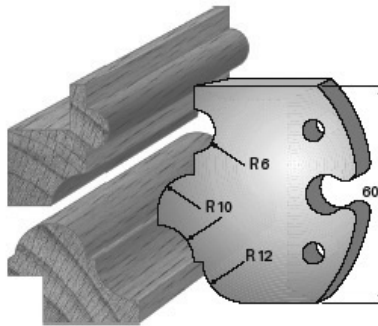

SP-Messer/Blade = Art.-Nr./Item no. 60001  
HS-Messer/Blade = Art.-Nr./Item no. 62001  
Abweiser/Deflector = Art.-Nr./Item no. 61001

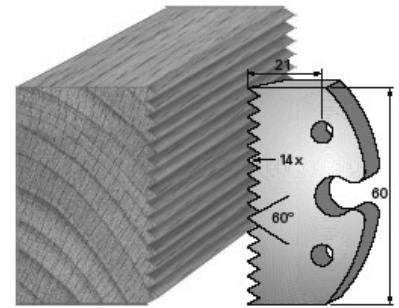

SP-Messer/Blade = Art.-Nr./Item no. 60003  
HS-Messer/Blade = Art.-Nr./Item no. 62003  
Abweiser/Deflector = Art.-Nr./Item no. 61003

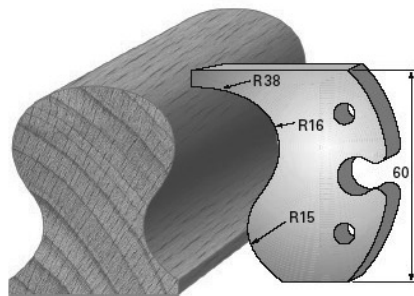

SP-Messer/Blade = Art.-Nr./Item no. 60004  
HS-Messer/Blade = Art.-Nr./Item no. 62004  
Abweiser/Deflector = Art.-Nr./Item no. 61004

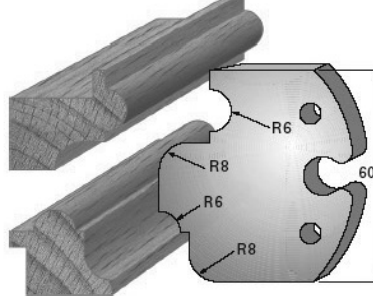

SP-Messer/Blade = Art.-Nr./Item no. 60006  
HS-Messer/Blade = Art.-Nr./Item no. 62006  
Abweiser/Deflector = Art.-Nr./Item no. 61006

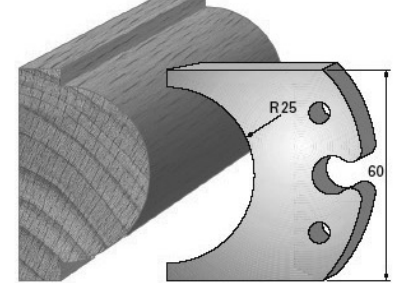

SP-Messer/Blade = Art.-Nr./Item no. 60008  
HS-Messer/Blade = Art.-Nr./Item no. 62008  
Abweiser/Deflector = Art.-Nr./Item no. 61008

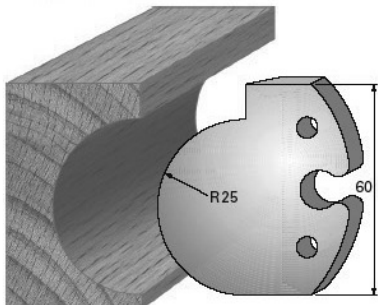

SP-Messer/Blade = Art.-Nr./Item no. 60009  
HS-Messer/Blade = Art.-Nr./Item no. 62009  
Abweiser/Deflector = Art.-Nr./Item no. 61009

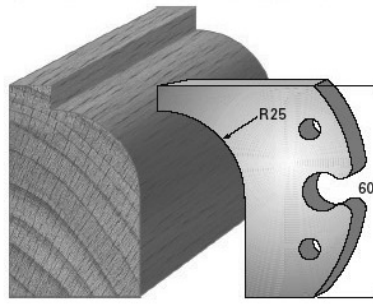

SP-Messer/Blade = Art.-Nr./Item no. 60010  
HS-Messer/Blade = Art.-Nr./Item no. 62010  
Abweiser/Deflector = Art.-Nr./Item no. 61010

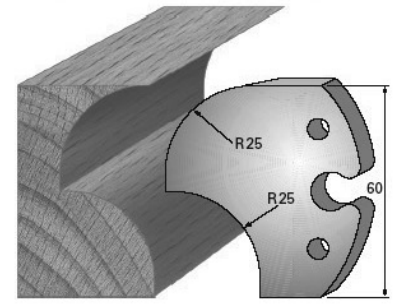

SP-Messer/Blade = Art.-Nr./Item no. 60011  
HS-Messer/Blade = Art.-Nr./Item no. 62011  
Abweiser/Deflector = Art.-Nr./Item no. 61011

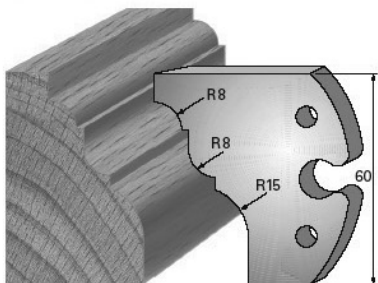

SP-Messer/Blade = Art.-Nr./Item no. 60012  
HS-Messer/Blade = Art.-Nr./Item no. 62012  
Abweiser/Deflector = Art.-Nr./Item no. 61012

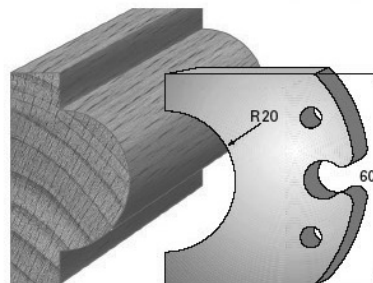

SP-Messer/Blade = Art.-Nr./Item no. 60016  
HS-Messer/Blade = Art.-Nr./Item no. 62016  
Abweiser/Deflector = Art.-Nr./Item no. 61016

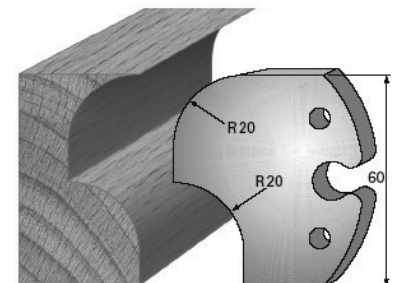

SP-Messer/Blade = Art.-Nr./Item no. 60019  
HS-Messer/Blade = Art.-Nr./Item no. 62019  
Abweiser/Deflector = Art.-Nr./Item no. 61019

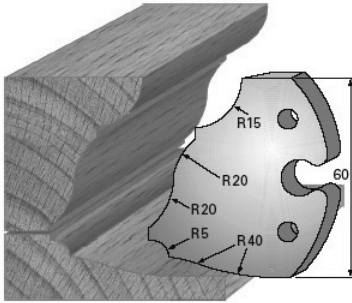

SP-Messer/Blade = Art.-Nr./Item no. 60020  
HS-Messer/Blade = Art.-Nr./Item no. 62020  
Abweiser/Deflector = Art.-Nr./Item no. 61020

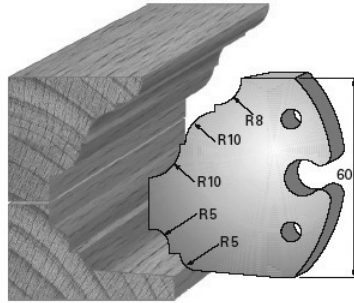

SP-Messer/Blade = Art.-Nr./Item no. 60021  
HS-Messer/Blade = Art.-Nr./Item no. 62021  
Abweiser/Deflector = Art.-Nr./Item no. 61021

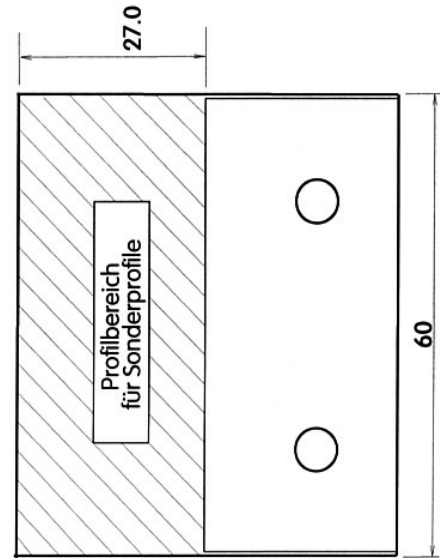

HS-Messer/Blade = Art.-Nr./Item no. 62500  
Abweiser Blankett/Deflector Blank = Art.-Nr./Item no. 61500

**Profilmesser 80 x 5,5 mm HS-Stahl - passend für SOLO-Profilmesserkopf Art.Nr. 3930**  
**Profiling blades 80 x 5,5 mm from high-speed-steel - for SOLO head Item no. 3930**

6

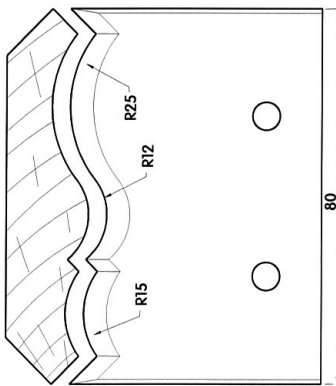

HS-Messer/Blade = Art.-Nr./Item no. 80001  
Abweiser/Deflector = Art.-Nr./Item no. 81001

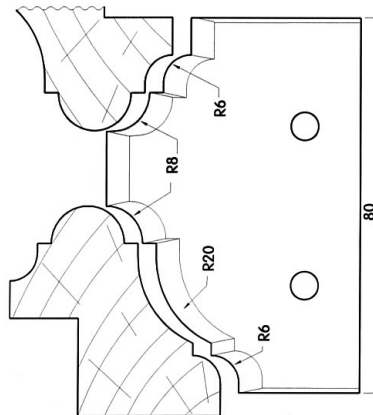

HS-Messer/Blade = Art.-Nr./Item no. 80002  
Abweiser/Deflector = Art.-Nr./Item no. 81002

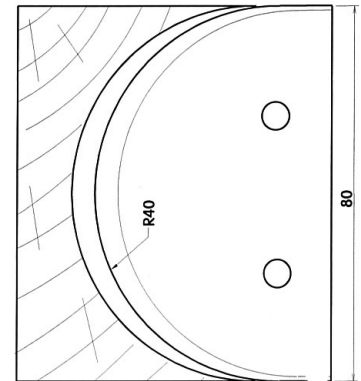

HS-Messer/Blade = Art.-Nr./Item no. 80003  
Abweiser/Deflector = Art.-Nr./Item no. 81003

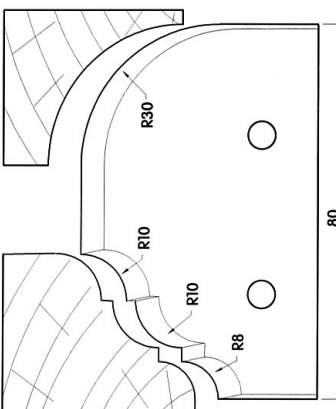

HS-Messer/Blade = Art.-Nr./Item no. 80004  
Abweiser/Deflector = Art.-Nr./Item no. 81004

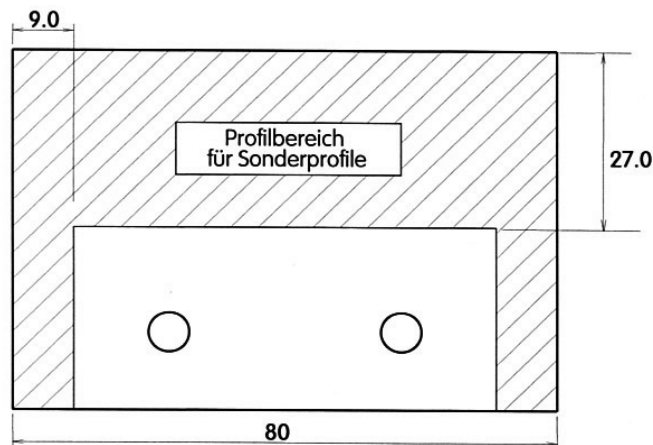

HS-Messer/Blade = Art.-Nr./Item no. 80500  
Abweiser Blankett/Deflector Blank = Art.-Nr./Item no. 81500

# Profilmesserkopf - rückenverzahnt **NEU**

## Head for profiling blades - serrated

### Ausführung:

Sicherheits-Profilmesserkopf mit exakt formschlüssiger Messereinspannung.

### Ohne Messerbestückung !

Verzahnung am Messerrücken und in der Messerauflage im Messerkopf.

Werkzeugkörper aus Stahl, für den Einsatz von 2 oder 4 Profilmesser mit 8 oder 10 mm Stärke mit Verzahnung am Messerrücken.

Beim Einsatz von nur 2 Profilmesser müssen die 2 gegenüberliegenden Einbaustellen durch 2 Blindstücke geschlossen werden

### Design:

Security head for profiling blades with exact and positive clamp of the blades.

### Without blade equipping!

Gearing at the rear of the blade and at the blade support in the cutter head.

Tool made from steel, for the use of 2 or 4 profile blades of 8 or 10 mm with rear gearing.

When using only 2 profile blades the opposing installation devices have to be equipped with 2 blind pieces to close them.

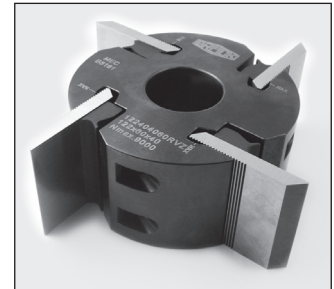

Art.-Nr./Item no.  
**122404060RVZ**

### Anwendung:

Zum Fräsen von Massivhölzern in Längsrichtung mit Profilmesser in HS-Qualität.

**Hartmetallbestückte Profilmesser für den Einsatz bei Harthölzern.**

### Application:

For the use on solid woods in longitudinal direction with profile blades in HS quality.

**Tungsten carbide profile blades usable for hardwood.**

Artikel-Nr. Item no.	D = mm	B = mm	d = mm	d = max. mm	Z	n/min max.	EURO Stck./pce
122404040RVZ	122	40	40	40	4	9.000	178,00
122404060RVZ	122	60	40	40	4	9.000	209,00
122404080RVZ	122	80	40	40	4	9.000	241,00
122404100RVZ	122	100	40	40	4	9.000	268,00
122404120RVZ	122	120	40	40	4	9.000	318,00
122404130RVZ	122	130	40	40	4	9.000	318,00
122404150RVZ	122	150	40	40	4	9.000	354,00
122404180RVZ	122	180	40	40	4	9.000	409,00
122404230RVZ	122	230	40	40	4	9.000	618,00
122404240RVZ	122	240	40	40	4	9.000	644,00
137404060RVZ	137	60	40	50	4	8.700	217,00
137404080RVZ	137	80	40	50	4	8.700	267,00
137404100RVZ	137	100	40	50	4	8.700	304,00
137404130RVZ	137	130	40	50	4	8.700	366,00
137404180RVZ	137	180	40	50	4	8.700	460,00
137404230RVZ	137	230	40	50	4	8.700	654,00

Andere Abmessungen und Ausführungen - auf Anfrage !

Profilmesser-Blanketten s. Seite 13.4

## UNI-Profilmesser Blanketts + Sonderprofile HS

### UNI profiling blades blanks + special profiles high-speed steel

Bezeichnung Description	Messer/Blade		Abweiser/Deflector		kpl. Satz**/cpl. set***	
	Art.-Nr. Item no.	EURO Stck./pce	Art.-Nr. Item no.	EURO Stck./pce	Art.-Nr. Item no.	EURO Stck./pce

#### UNI-Profil 40 x 4 mm/UNI profiles 40 x 4 mm

passend für Art.-Nr./suitable for items no. 3500; 3501; 3502; 3503; 3504; 3505; 3910; 3911

Blanketts – HS/Blanks – high-speed steel	36900	13,00	37999	6,30		
Blanketts – SP/Blanks – special steel	36901	6,40	37999	6,30		

SONDERPROFILE (in HS-Qualität) – max. Profiltiefe = 15 mm/SPECIAL PROFILES with jig (high-speed steel)

Profilgruppe I*/Profile category I*					38300	195,50
Profilgruppe II*/Profile category II*					38301	211,20
Profilgruppe III*/Profile category III*					38302	242,50

nur Messer bei Nachbestellung/pro Paar/only blades (repeat order)/pair

Profilgruppe I*/Profile category I*	36910	105,80				
Profilgruppe II*/Profile category II*	36920	114,00				
Profilgruppe III*/Profile category III*	36930	134,50				

#### UNI-Profil 50 x 4 mm/UNI profiles 50 x 4 mm

passend für Art.-Nr./suitable for items no. 3910; 3911

Blanketts – HS/Blanks – high-speed steel	36903	23,70	37306	12,90		
--	-------	-------	-------	-------	--	--

SONDERPROFILE (in HS-Qualität) – max. Profiltiefe = 15 mm/SPECIAL PROFILES with jig (high-speed steel)

Profilgruppe I*/Profile category I*					38307	211,20
Profilgruppe II*/Profile category II*					38308	226,70
Profilgruppe III*/Profile category III*					38309	258,00

nur Messer bei Nachbestellung/pro Paar/only blades (repeat order)/pair

Profilgruppe I*/Profile category I*	36911	117,90				
Profilgruppe II*/Profile category II*	36921	126,60				
Profilgruppe III*/Profile category III*	36931	149,20				

#### Großprofilmesser 60 x 5,5 mm/Large profile blades 60 x 5,5 mm

passend für Art.-Nr./suitable for items no. 3920; 3921

Blanketts – HS/Blanks – high-speed steel	62500	43,20	61500	8,80		
--	-------	-------	-------	------	--	--

SONDERPROFILE (in HS-Qualität) – max. Profiltiefe = 27 mm/SPECIAL PROFILES with jig (high-speed steel)

Profilgruppe I*/Profile category I*					38310	248,10
Profilgruppe II*/Profile category II*					38311	273,30
Profilgruppe III*/Profile category III*					38312	295,40

nur Messer bei Nachbestellung/pro Paar/only blades (repeat order)/pair

Profilgruppe I*/Profile category I*	36912	216,80				
Profilgruppe II*/Profile category II*	36922	237,00				
Profilgruppe III*/Profile category III*	36932	266,10				

#### Großprofilmesser 80 x 5,5 mm/Large profile blades 80 x 5,5 mm

passend für Art.-Nr./suitable for items no. 3930; 3931

Blanketts/Blanks 80 x 5,5 mm			80500	64,20	81500	33,10
------------------------------	--	--	-------	-------	-------	-------

SONDERPROFILE (in HS-Qualität) – max. Profiltiefe = 27 mm/SPECIAL PROFILES with jig (high-speed steel)

Profilgruppe I*/Profile category I*					38320	351,60
Profilgruppe II*/Profile category II*					38321	378,00
Profilgruppe III*/Profile category III*					38322	423,80

nur Messer bei Nachbestellung/pro Paar/only blades (repeat order)/pair

Profilgruppe I*/Profile category I*	36914	320,00				
Profilgruppe II*/Profile category II*	36924	346,00				
Profilgruppe III*/Profile category III*	36934	389,60				

\* Profilgruppe I – III siehe separate Aufstellung nächste Seite

\*\* kpl. Satz = 2 Messer/2 Abweiser

\* For profile categories I – III, see list on the next page

\*\* complete set = 2 blades/2 deflectors

# Schärfpreise für UNI-Profilmesser, Sonderprofile und Abweiser

## Prices of sharpening/UNI profiling blades, special profiles and deflectors

Ausführung Description	Werkstoff Material	Messer/Blade Art.-Nr. Item no.	EURO Stck./pce	Abweiser/Deflector Art.-Nr. Item no.	EURO Stck./pce
---------------------------	-----------------------	--------------------------------------	-------------------	--	-------------------

### UNI-Profil 40 mm/UNI profiles 40 mm

Profilgruppe I*/Profile category I*	HS/SP/High-speed steel/special steel	363001	19,30	373001	17,30
Profilgruppe II*/Profile category II*	HS/SP/High-speed steel/special steel	363011	22,90	373011	19,40
Profilgruppe III*/Profile category III*	HS/SP/High-speed steel/special steel	363021	26,00	373021	21,30

### UNI-Profil 50 mm/UNI profiles 50 mm

Profilgruppe I*/Profile category I*	HS/SP/High-speed steel/special steel	363071	20,60	373071	18,50
Profilgruppe II*/Profile category II*	HS/SP/High-speed steel/special steel	363081	24,40	373081	21,20
Profilgruppe III*/Profile category III*	HS/SP/High-speed steel/special steel	363091	28,30	373091	24,50

### Großprofile 60 + 59/64 mm/Large profiles 60 + 59/64 mm

Profilgruppe I*/Profile category I*	HS/SP/High-speed steel	363141	27,60	373141	22,50
Profilgruppe II*/Profile category II*	HS/SP/High-speed steel	363151	31,60	373151	25,80
Profilgruppe III*/Profile category III*	HS/SP/High-speed steel	363161	35,30	373161	29,10

### Großprofile 80 mm/Large profiles 80 mm

Profilgruppe I*/Profile category I*	HS/High-speed steel	363241	35,90	373241	29,20
Profilgruppe II*/Profile category II*	HS/High-speed steel	363251	41,10	373251	33,50
Profilgruppe III*/Profile category III*	HS/High-speed steel	363261	36,80	373261	37,80

\* Profilgruppe I – III siehe separate Aufstellung unten

\* For profile categories I – III, see list below

## Profilgruppeneinteilung/Profile categories

### Profilgruppe I

einfache und einseitig in sich hinterschliffene Profile

#### Profile category I

simple profiles, relief-ground on one side

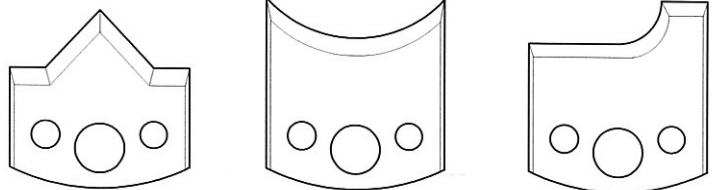

### Profilgruppe II

komplizierte und beidseitig in sich hinterschliffene Profile

#### Profile category II

complex profiles, relief-ground on both sides

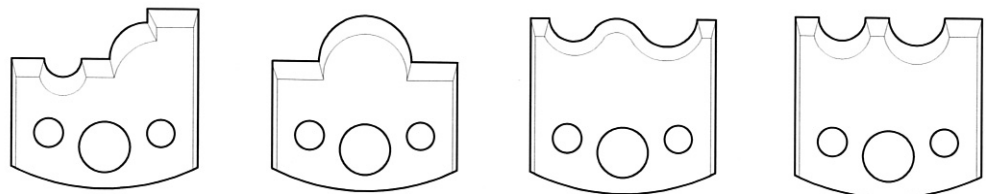

### Profilgruppe III

in sich ineinander passende Profile und Konterprofile

#### Profile category III

Matching profiles and counter profiles

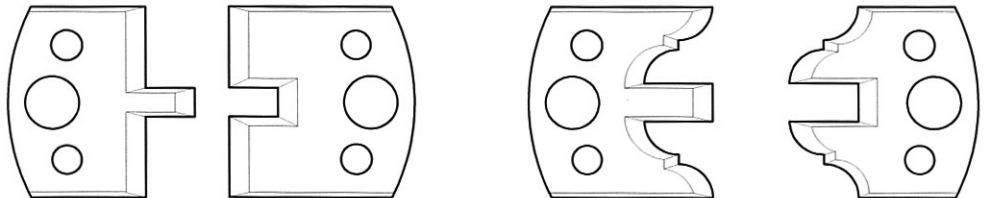

### Drehschema für Fräser

#### Cutter rotating modes



Normalschema 1 großer Ø  
oben Rechtslauf  
Mode 1 (standard) large Ø on  
upper side, right-handed rotation

Drehschema 2 großer Ø  
oben Linkslauf  
Mode 2 large Ø on upper  
side, left-handed rotation

Drehschema 3 großer Ø  
unten Rechtslauf  
Mode 3 large Ø on lower  
side, right-handed rotation

Drehschema 4 großer Ø  
unten Linkslauf  
Mode 4 large Ø on lower  
side, left-handed rotation





UNIVERSAL-Messerköpfe und Profilmesser  
*UNIVERSAL heads and profiling blades*

6  
CNC

**Produktbezeichnung / Product description**

**Seite / Page**

**CNC Werkzeug-Technik / CNC Tool-Technique**

UNIVERSAL-Profilmesserkopf  
*UNIVERSAL head for profiling blades* ..... 6.34

# UNIVERSAL-Profilmesserkopf für CNC-Maschinen



## UNIVERSAL head for profiling blades for CNC- machines

### Ausführung:

Werkzeugkörper aus Stahl zur Aufnahme von UNI-Profilmesser **40 x 4 mm und 50 x 4 mm**, ausgerüstet mit SP-Falzmesser 40 x 4 x 16 mm.

Für mechan. Vorschub (MEC).

### Design:

Tool body made from steel for profile blades **40 x 4 mm and 50 x 4 mm**, equipped with SP- rebating blades 40 x 4 x 16 mm.

For router machines with mechanical feed.

### Anwendung:

Zum universellen Profilieren von Massivholz auf CNC-Oberfräsen. Für Schnittbreite **40 mm und 50 mm**. Profilmesser der gleichen Profildimension sind stets paarweise einzusetzen.

Die Profilmesser sind in SP-, HS-Stahl und in Hartmetall lieferbar!

### Application:

For universal profiling of solid wood on CNC router machines. For cutting width **40 mm and 50 mm**. Profile blades may only be ordered and used in pairs.

The profile blades can be delivered in SP-, HSS-Steel and tungsten carbide!



Art.-Nr./Item no. 133500

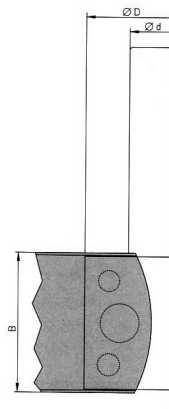

Artikel-Nr. Item no.	Bezeichnung/Abmessung mm Description/Dimensions mm	Schaft	Z	n/min <sup>-1</sup> max	EURO Stck./pce
133500	UNI-Profilmesserkopf 66 x 40/50 UNI head for profiling blades 66 x 40/50	20	2	12.000	214,00
133501	UNI-Profilmesserkopf 66 x 40/50 UNI head for profiling blades 66 x 40/50	25	2	12.000	214,00

UNI-Profilmesser für o.g. Werkzeuge siehe BRÜCK-Katalog 2008 (Katalog-Seiten 6.4 - 6.31) und HW-Multi-Profil-System (Seiten 6.17 - 6.18)

UNI profile blades for those tools can be found in the BRÜCK-Catalogue 2008 (pages 6.4 - 6.31) and TC multi-profile-system (pages 6.17 - 6.18)

Andere Abmessungen und Ausführungen – auf Anfrage.  
Verpackungseinheit für Profilmesser: 2 Stück

Other dimensions and specifications on request.  
Packing quantities for profile blades: 2 pcs.